

# HIGH VALUE PARTS CATALOGUE

Wolfking® - CFS® - GEA® - Krämer & Grebe® - Simo® - Wolfking® - CFS® - GEA® - Krämer & Grebe® - Simo®

Wolfking® - CFS® - GEA® - Krämer & Grebe® - Simo® - Wolfking® - CFS® - GEA® - Krämer & Grebe® - Simo®

Wolfking® - CFS® - GEA® - Krämer & Grebe® - Simo® - Wolfking® - CFS® - GEA® - Krämer & Grebe® - Simo®

Wolfking® - CFS® - GEA® - Krämer & Grebe® - Simo® - Wolfking® - CFS® - GEA® - Krämer & Grebe® - Simo®

Wolfking® - CFS® - GEA® - Krämer & Grebe® - Simo® - Wolfking® - CFS® - GEA® - Krämer & Grebe® - Simo®

Wolfking® - CFS® - GEA® - Krämer & Grebe® - Simo® - Wolfking® - CFS® - GEA® - Krämer & Grebe® - Simo®

Wolfking® - CFS® - GEA® - Krämer & Grebe® - Simo® - Wolfking® - CFS® - GEA® - Krämer & Grebe® - Simo®

Wolfking® - CFS® - GEA® - Krämer & Grebe® - Simo® - Wolfking® - CFS® - GEA® - Krämer & Grebe® - Simo®

Wolfking® - CFS® - GEA® - Krämer & Grebe® - Simo® - Wolfking® - CFS® - GEA® - Krämer & Grebe® - Simo®

Wolfking® - CFS® - GEA® - Krämer & Grebe® - Simo® - Wolfking® - CFS® - GEA® - Krämer & Grebe® - Simo®

Wolfking® - CFS® - GEA® - Krämer & Grebe® - Simo® - Wolfking® - CFS® - GEA® - Krämer & Grebe® - Simo®

Wolfking® - CFS® - GEA® - Krämer & Grebe® - Simo® - Wolfking® - CFS® - GEA® - Krämer & Grebe® - Simo®

Wolfking® - CFS® - GEA® - Krämer & Grebe® - Simo® - Wolfking® - CFS® - GEA® - Krämer & Grebe® - Simo®

Wolfking® - CFS® - GEA® - Krämer & Grebe® - Simo® - Wolfking® - CFS® - GEA® - Krämer & Grebe® - Simo®

Wolfking® - CFS® - GEA® - Krämer & Grebe® - Simo® - Wolfking® - CFS® - GEA® - Krämer & Grebe® - Simo®

Wolfking® - CFS® - GEA® - Krämer & Grebe® - Simo® - Wolfking® - CFS® - GEA® - Krämer & Grebe® - Simo®

Wolfking® - CFS® - GEA® - Krämer & Grebe® - Simo® - Wolfking® - CFS® - GEA® - Krämer & Grebe® - Simo®

Wolfking® - CFS® - GEA® - Krämer & Grebe® - Simo® - Wolfking® - CFS® - GEA® - Krämer & Grebe® - Simo®

Wolfking® - CFS® - GEA® - Krämer & Grebe® - Simo® - Wolfking® - CFS® - GEA® - Krämer & Grebe® - Simo®

Wolfking® - CFS® - GEA® - Krämer & Grebe® - Simo® - Wolfking® - CFS® - GEA® - Krämer & Grebe® - Simo®

Wolfking® - CFS® - GEA® - Krämer & Grebe® - Simo® - Wolfking® - CFS® - GEA® - Krämer & Grebe® - Simo®

Wolfking® - CFS® - GEA® - Krämer & Grebe® - Simo® - Wolfking® - CFS® - GEA® - Krämer & Grebe® - Simo®

Wolfking® - CFS® - GEA® - Krämer & Grebe® - Simo® - Wolfking® - CFS® - GEA® - Krämer & Grebe® - Simo®

Wolfking® - CFS® - GEA® - Krämer & Grebe® - Simo® - Wolfking® - CFS® - GEA® - Krämer & Grebe® - Simo®

Wolfking® - CFS® - GEA® - Krämer & Grebe® - Simo® - Wolfking® - CFS® - GEA® - Krämer & Grebe® - Simo®

Wolfking® - CFS® - GEA® - Krämer & Grebe® - Simo® - Wolfking® - CFS® - GEA® - Krämer & Grebe® - Simo®

Wolfking® - CFS® - GEA® - Krämer & Grebe® - Simo® - Wolfking® - CFS® - GEA® - Krämer & Grebe® - Simo®

Wolfking® - CFS® - GEA® - Krämer & Grebe® - Simo® - Wolfking® - CFS® - GEA® - Krämer & Grebe® - Simo®

Wolfking® - CFS® - GEA® - Krämer & Grebe® - Simo® - Wolfking® - CFS® - GEA® - Krämer & Grebe® - Simo®

Wolfking® - CFS® - GEA® - Krämer & Grebe® - Simo® - Wolfking® - CFS® - GEA® - Krämer & Grebe® - Simo®

Wolfking® - CFS® - GEA® - Krämer & Grebe® - Simo® - Wolfking® - CFS® - GEA® - Krämer & Grebe® - Simo®

Wolfking® - CFS® - GEA® - Krämer & Grebe® - Simo® - Wolfking® - CFS® - GEA® - Krämer & Grebe® - Simo®

Wolfking® - CFS® - GEA® - Krämer & Grebe® - Simo® - Wolfking® - CFS® - GEA® - Krämer & Grebe® - Simo®

Wolfking® - CFS® - GEA® - Krämer & Grebe® - Simo® - Wolfking® - CFS® - GEA® - Krämer & Grebe® - Simo®

Wolfking® - CFS® - GEA® - Krämer & Grebe® - Simo® - Wolfking® - CFS® - GEA® - Krämer & Grebe® - Simo®

Wolfking® - CFS® - GEA® - Krämer & Grebe® - Simo® - Wolfking® - CFS® - GEA® - Krämer & Grebe® - Simo®

Wolfking® - CFS® - GEA® - Krämer & Grebe® - Simo® - Wolfking® - CFS® - GEA® - Krämer & Grebe® - Simo®

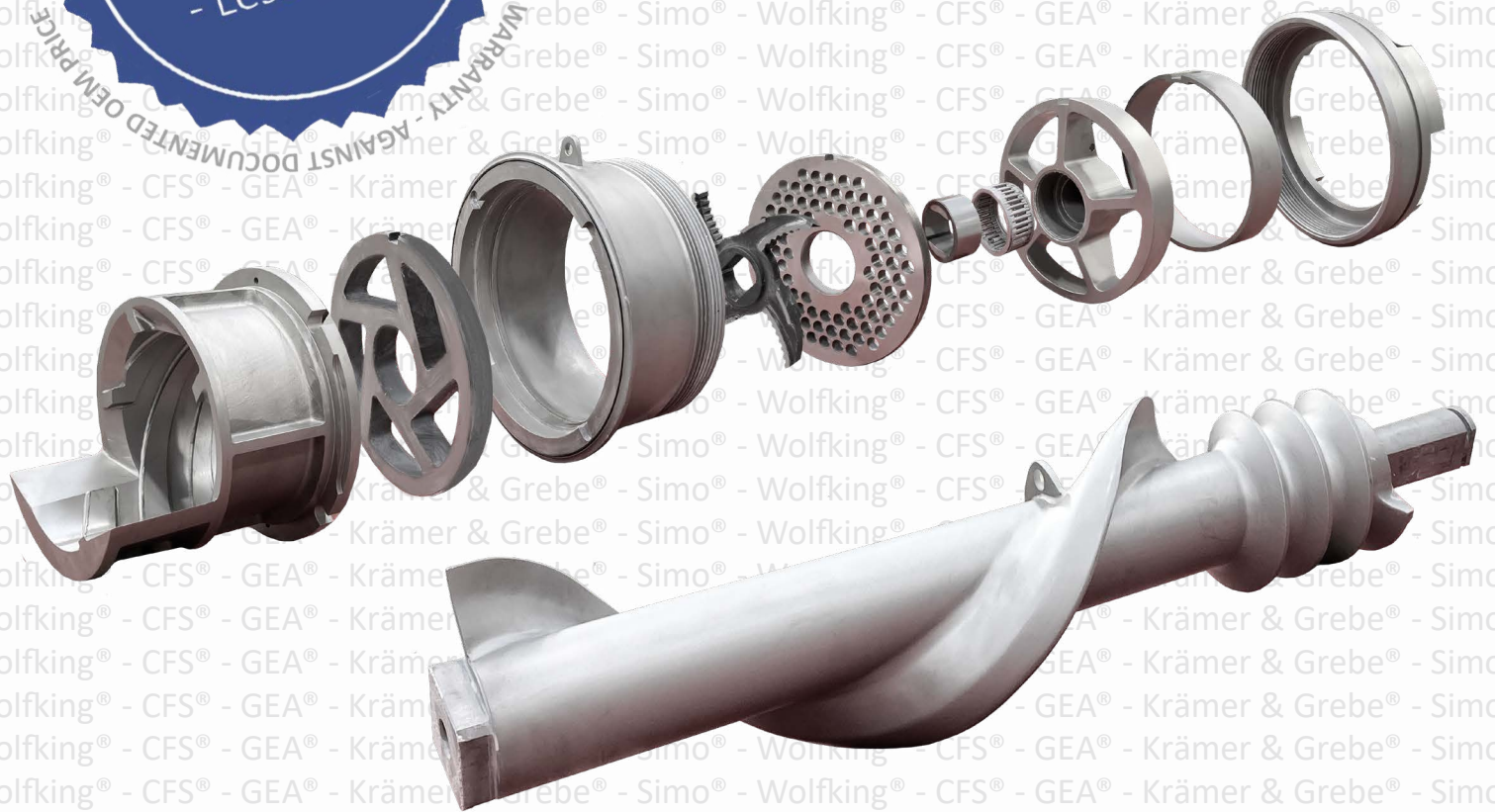

[www.koncepttech.com](http://www.koncepttech.com)

Koncept Tech ApS, Industrivej 6, DK-4200 Slagelse, Denmark, Phone: +45 70271410 E-mail: [parts@koncepttech.com](mailto:parts@koncepttech.com)

All items, parts, and accessories listed on the website of Koncept Tech ApS, are manufactured by Koncept Tech ApS, or manufactured to Koncept Tech ApS, specifications. The names of the original equipment manufacturers referred to on this site, such as but not limited to: Camiltech®, Handlmann®, K&G®, Krämer + Grebe®, CFS®, GEA®, Karl Schnell®, KS®, Laska®, Palma®, Pelmo®, Seydelmann®, Simo®, Haarslev®, Weiler®, Mincomaster®, ANCO®, Cozzini®, The Middleby Corporation®, Wolfking®, Comvair®, Auto®, Beehive®, Yieldmaster®, Meatmaker®, Poss®, Townsend®, Lima®, etc., are all registered trademarks of their respective companies. All original equipment manufacturer's names are listed as Camiltech® type, Handlmann® type, K&G® type, Krämer + Grebe® type, CFS® type, Karl Schnell® type, KS® type, Laska® type, Palma® type, Pelmo® type, Seydelmann® type, Simo® type, Haarslev® type, Weiler® type, Mincomaster® type, ANCO® type, Cozzini® type, Wolfking® type, Comvair® type, Auto® type, Beehive® type, Yieldmaster® type, Meatmaker® type, Poss® type, Townsend® type, Lima® type to indicate that these items are manufactured by Koncept Tech ApS, and not the original equipment manufacturers. Unless specifically stated otherwise, Koncept Tech ApS, has no association or affiliation with any entities/companies listed.



Follow us on LinkedIn

Follow us on Facebook

## Global Price Warranty - Against documented OEM price

**Wolfking® – CFS® – GEA® – Krämer & Grebe® – Simo® – Cozzini®**

Koncept Tech ApS maintains a global price warranty against documented OEM price (Original Equipment Manufacturer). If, for any, reason our customer can document that the OEM price is cheaper than the quoted price from Koncept Tech, Koncept Tech shall match the documented price PLUS deduct further 10% from the said part price. All prices are quoted Ex works our factory in Denmark. Koncept Tech ApS may reserve the right to sell and deliver 1 (one) part of each part, or set, for parts covered by price warranty per customer.

This price warranty is valid for ALL parts listed in Koncept Tech High Value Parts catalogue, latest version/edition. Please find Koncept Tech High Value Parts catalogue.





## List of Contents

### Grinder Parts for Wolfking®/CFS®/GEA®/Krämer / Grebe®/Simo® Grinders:

Auger/Worm .....	18-22
AutoGrind 200 .....	55
AutoGrind 280 .....	56-59
Bushing .....	6
Cabinet Dimensions .....	53
D-Nut .....	6
Flange with Square Hole .....	27
Gear Box Parts .....	34-43
Grinder C.250/C.300-UNI .....	45-47
Grinder C.400-UNI .....	48-51
Knife Housing .....	31-33
Lining .....	28-30
Overview of Grinder Types .....	5
Pilot Bearing .....	6-13
Poly-V Belt .....	17
Pulley .....	16
Roller Bearing .....	6
Screw Cap .....	14-15
Simo® Grinder Parts .....	54
Support Ring for Screw Cap .....	52
Worm Pin .....	23-26

### Electrical Parts:

Miscellaneous Electrical Parts .....	44
--------------------------------------	----

### Cozzini®: Grinder, Emulsifier & Pump Parts:

AR 901- Parts .....	122
Cozzini® -Miscellaneous Parts .....	123
Cozzini® Pumps .....	111-114
CPG 400- Parts .....	117-120
EM 701- Parts .....	122

### Emulsifier Parts for Wolfking®/CFS®/GEA® Emulsifiers:

EcoCutE.225 .....	60-79
QuadroCut225/EcoCut E.225 .....	80-81

### Microcutter Parts for Simo® Microcutters:

MC 200 .....	82
MC 250 .....	83-91



Follow us on LinkedIn  
Follow us on Facebook

### List of Contents, Continued

**Mixer & Mixer/Grinder Parts for Wolfking® / CFS® / GEA® / Simo® Mixers & Mixer/Grinders:**

Mixer & Mixer/Grinder Parts.....	92-95
Mixing Wing Seal Assembly.....	96-98
Overview of Mixer & Mixer Grinder Types .....	92-93

**Pump Parts:**

CFD Unit.....	102-103
Contiflow Pump.....	104-109
Simo® 200, 250 & 290.....	99-101

**Mechanical Deboning Machine Parts:**

RecoScreen 100 & Reco Screen 20.....	115-116
--------------------------------------	---------

**Various:**

Meet Our Global Team.....	130-133
New Machines .....	129
Refurbishments & Exchange Parts.....	125-128



Follow us on LinkedIn



Follow us on Facebook

## Wolfking® / CFS® / GEA® / Simo® Grinder Parts

### We Supply Parts for The Following Mincers/Grinders:

GEA® PowerGrind 280

GEA® AutoGrind280

GEA® AutoGrind200

GEA® UniGrind160

GEA® UniGrind200

GEA® UniGrind250

GEA® ComboGrind 1500/250

GEA® MaxiGrind 400

GEA® MaxiGrind 400 HD

CFS® PowerGrind 280

CFS® AutoGrind280

CFS® AutoGrind200

CFS® UniGrind160

CFS® UniGrind200

CFS® UniGrind250

CFS® SpeedGrind 250

CFS® ComboGrind 1500/250

CFS® ComboGrind 850/200

CFS® MaxiGrind 400

CFS® MaxiGrind 400 HD

CFS® ChunkMaster 400

CFS® SuperGrind 300/150

CFS® SuperGrind 300/230

CFS® SuperGrind 400/190

CFS® SuperGrind 400/260

CFS® SuperGrind 400/260-HD

CFS® SuperGrind 550/260-HD

CFS® ComboGrind 850/200

CFS® ComboGrind 1500/250

CFS® SpeedGrind 250/75

CFS® SpeedGrind 250/125

Wolfking® Walian 140

Wolfking® C.160-UNI (L or S)

Wolfking® C.200-UNI (L or S)

Wolfking® C.250-UNI (L, S or S2T)

Wolfking® C.300-UNI (L, S or S2T)

Wolfking® C.300 Frozen Block Grinder

Wolfking® C.400-UNI-(L, S or S2T)

Wolfking® C.400-UNI-HD (S or S2T)

Wolfking® C.400-2T70

Wolfking® B.400-UNI-(L, S or S2T)

Wolfking® B.400-UNI-HD (L, S or S2T)

Wolfking® BB.400

Wolfking® BF.400

Wolfking® BMF.400

Wolfking® Self Feeding Grinder, SFG.800/200

Wolfking® Self Feeding Grinder, SFG.1500/250

Wolfking® Homogenizer 250/75

Wolfking® Homogenizer 250/125

Simo® SuperGrind 300/150

Simo® SuperGrind 300/230

Simo® SuperGrind 400/190

Simo® SuperGrind 400/260

Simo® SuperGrind 400/260-HD

Simo® SuperGrind 550/260-HD

HD = Heavy Duty

## Wolfking® / CFS® / GEA® / Simo® Grinder Part - D-nut, Bushing, Roller Bearing



D-nut, lining, and roller bearing

D-nut, roller bearing, and lining

Machine Type	D-Nut	Bushing	Roller Bearing
Wolfking® C.160-UNI CFS® UniGrind 160 GEA® UniGrind 160	5000030667 <input checked="" type="checkbox"/> 30667 <input checked="" type="checkbox"/>	5000030991 <input checked="" type="checkbox"/> 30991	N/A
Wolfking® C.200-UNI CFS® UniGrind 200 GEA® UniGrind 200	5000030664 <input checked="" type="checkbox"/> 30664 <input checked="" type="checkbox"/>	5000030819 <input checked="" type="checkbox"/> 30819 <input checked="" type="checkbox"/>	N/A
Wolfking® C.250-UNI CFS® UniGrind 250 GEA® UniGrind 250	5000030005 <input checked="" type="checkbox"/> 30005 <input checked="" type="checkbox"/>	5000031246 <input checked="" type="checkbox"/> 31246 <input checked="" type="checkbox"/>	5000031177 <input checked="" type="checkbox"/> 31177 <input checked="" type="checkbox"/>
Wolfking® C.250-UNI CFS® UniGrind 250 GEA® UniGrind 250	5000030005 <input checked="" type="checkbox"/> 30005 <input checked="" type="checkbox"/>	5000030033 30033	<b>(for pilot bearing without roller bearing)</b>
Wolfking® C.300-UNI Wolfking® C.300 Frozen Block Grinder	5000036588 <input checked="" type="checkbox"/> 36588 <input checked="" type="checkbox"/>	5000035920 <input checked="" type="checkbox"/> 35920 <input checked="" type="checkbox"/>	5000036587 <input checked="" type="checkbox"/> 36587 <input checked="" type="checkbox"/>
Wolfking® C.400-UNI Wolfking® C.400-UNI-HD Wolfking® C.400-2T70 Wolfking® B.400-UNI Wolfking® B.400-UNI-HD Wolfking® BB.400 Wolfking® BF.400 Wolfking® BMF.400 CFS® MaxiGrind 400 CFS® MaxiGrind 400 HD CFS® ChunkMaster400 GEA® MaxiGrind 400 GEA® MaxiGrind 400 HD	5000309664 <input checked="" type="checkbox"/> 30966 <input checked="" type="checkbox"/> 5000030666 <input checked="" type="checkbox"/> 30666 <input checked="" type="checkbox"/>	5000030378 <input checked="" type="checkbox"/> 30378 <input checked="" type="checkbox"/> 5000032554 <input checked="" type="checkbox"/> 32554 <input checked="" type="checkbox"/>	32549 <input checked="" type="checkbox"/> 32549 <input checked="" type="checkbox"/>

HD = Heavy Duty



Follow us on LinkedIn

Follow us on Facebook







## Wolfking® / CFS® / GEA® / Simo® Grinder Parts - Pilot Bearing

Machine Type	Pilot Bearing
Wolfking® C.160-UNI CFS® UniGrind 160 GEA® UniGrind 160	5000030353 <input checked="" type="checkbox"/> 30353 <input checked="" type="checkbox"/>
Wolfking® C.200-UNI CFS® UniGrind 200 GEA® UniGrind 200	5000030343 <input checked="" type="checkbox"/> 30343 <input checked="" type="checkbox"/>
Wolfking® C.250-UNI CFS® UniGrind 250 GEA® UniGrind 250	5000030351 <input checked="" type="checkbox"/> 30351 <input checked="" type="checkbox"/> 5000367446 <input checked="" type="checkbox"/> 367446 <input checked="" type="checkbox"/>
Wolfking® C.300-UNI Wolfking® C.300 Frozen Block Grinder	5000035921 <input checked="" type="checkbox"/> 35921 <input checked="" type="checkbox"/>
Wolfking® C.400-UNI Wolfking® C.400-UNI-HD Wolfking® C.400-2T70 Wolfking® B.400-UNI Wolfking® B.400-UNI-HD Wolfking® BB.400 Wolfking® BF.400 Wolfking® BMF.400 CFS® MaxiGrind 400 CFS® MaxiGrind 400 HD CFS® ChunkMaster400 GEA® MaxiGrind 400 GEA® MaxiGrind 400 HD	5000032555 <input checked="" type="checkbox"/> 32555 <input checked="" type="checkbox"/> 5000365446 <input checked="" type="checkbox"/> 365446 <input checked="" type="checkbox"/>

Machine Type	Pilot Bearing without Roller Bearing
Wolfking® C.250-UNI CFS® UniGrind 250 GEA® UniGrind 250	31174 <input checked="" type="checkbox"/>
Wolfking® C.400-UNI Wolfking® B.400-UNI	30552 <input checked="" type="checkbox"/>





HD = Heavy Duty

## Wolfking® / CFS® / GEA® / Simo® Grinder Parts - Pilot bearing (Cont.)

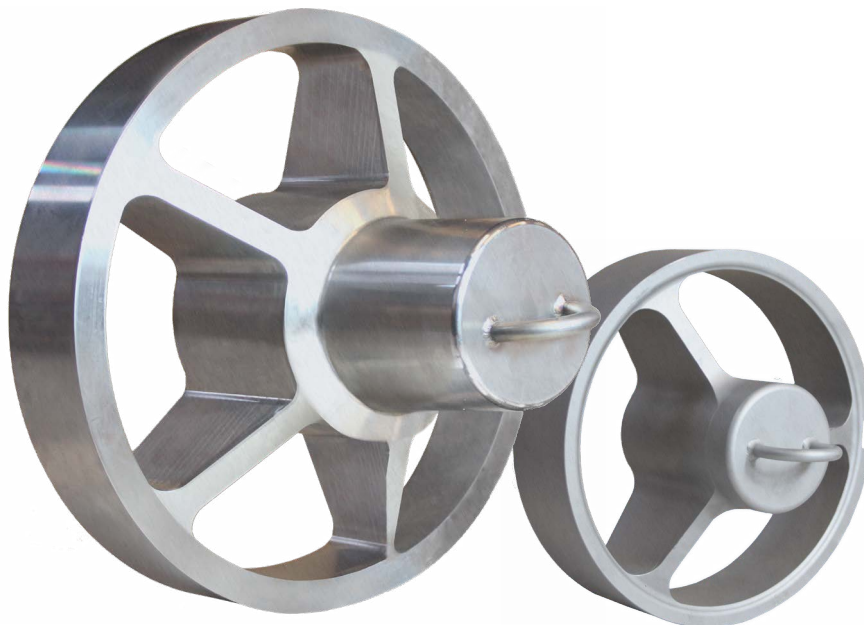
Machine Type	Pilot Bearing
Wolfking® C.400-UNI Wolfking® C.400-UNI-HD Wolfking® C.400-2T70 Wolfking® B.400-UNI Wolfking® B.400-UNI-HD Wolfking® BB.400 Wolfking® BF.400 Wolfking® BMF.400 CFS® MaxiGrind 400 CFS® MaxiGrind 400 HD CFS® ChunkMaster400 GEA® MaxiGrind 400 GEA® MaxiGrind 400 HD	5000404247  404247  <b>(closed pilotbearing)</b>
CFS® AutoGrind 200 GEA® AutoGrind 200	5000452319  452319 
CFS® AutoGrind 280 GEA® AutoGrind 280	5000452402  452402 
Simo® SuperGrind 300/150 Simo® SuperGrind 300/230	3508-37 

HD = Heavy Duty



Pilot bearing C.250,  
 part number 5000032555  / 32555   
 5000367446  / 367446 

[www.koncepttech.com](http://www.koncepttech.com)

Koncept Tech ApS, Industrivej 6, DK-4200 Slagelse, Denmark, Phone: +45 70271410 E-mail: [parts@koncepttech.com](mailto:parts@koncepttech.com)

All items, parts, and accessories listed on the website of Koncept Tech ApS, are manufactured by Koncept Tech ApS, or manufactured to Koncept Tech ApS specifications. The names of the original equipment manufacturers referred to on this site, such as but not limited to: Camiltech®, Handtmann®, K&G®, Krämer + Grebe®, CFS®, GEA®, Karl Schnell®, KS®, Laska®, Palma®, Pelsmo®, Seydelmann®, Simo®, Haarslev®, Weiler®, Mincomaster®, ANCO®, Cozzini®, The Middleby Corporation®, Wolfking®, Comvair®, Auto®, Beehive®, Yieldmaster®, Meatmaker®, Poss®, Townsend®, Lima®, etc., are all registered trademarks of their respective companies. All original equipment manufacturer's names are listed as Camiltech® type, Handtmann® type, K&G® type, Krämer + Grebe® type, CFS® type, Karl Schnell® type, KS® type, Laska® type, Palma® type, Pelsmo® type, Seydelmann® type, Simo® type, Haarslev® type, Weiler® type, Mincomaster® type, ANCO® type, Cozzini® type, Wolfking® type, Comvair® type, Auto® type, Beehive® type, Yieldmaster® type, Meatmaker® type, Poss® type, Townsend® type, Lima® type to indicate that these items are manufactured by Koncept Tech ApS, and not the original equipment manufacturers. Unless specifically stated otherwise, Koncept Tech ApS, has no association or affiliation with any entities/companies listed.



## Wolfking® / CFS® / GEA® / Simo® Grinder Parts - Pilot Bearing (Cont.)

### Exploded View of Closed Pilot Bearing, Part Number 5000404247 / 404247

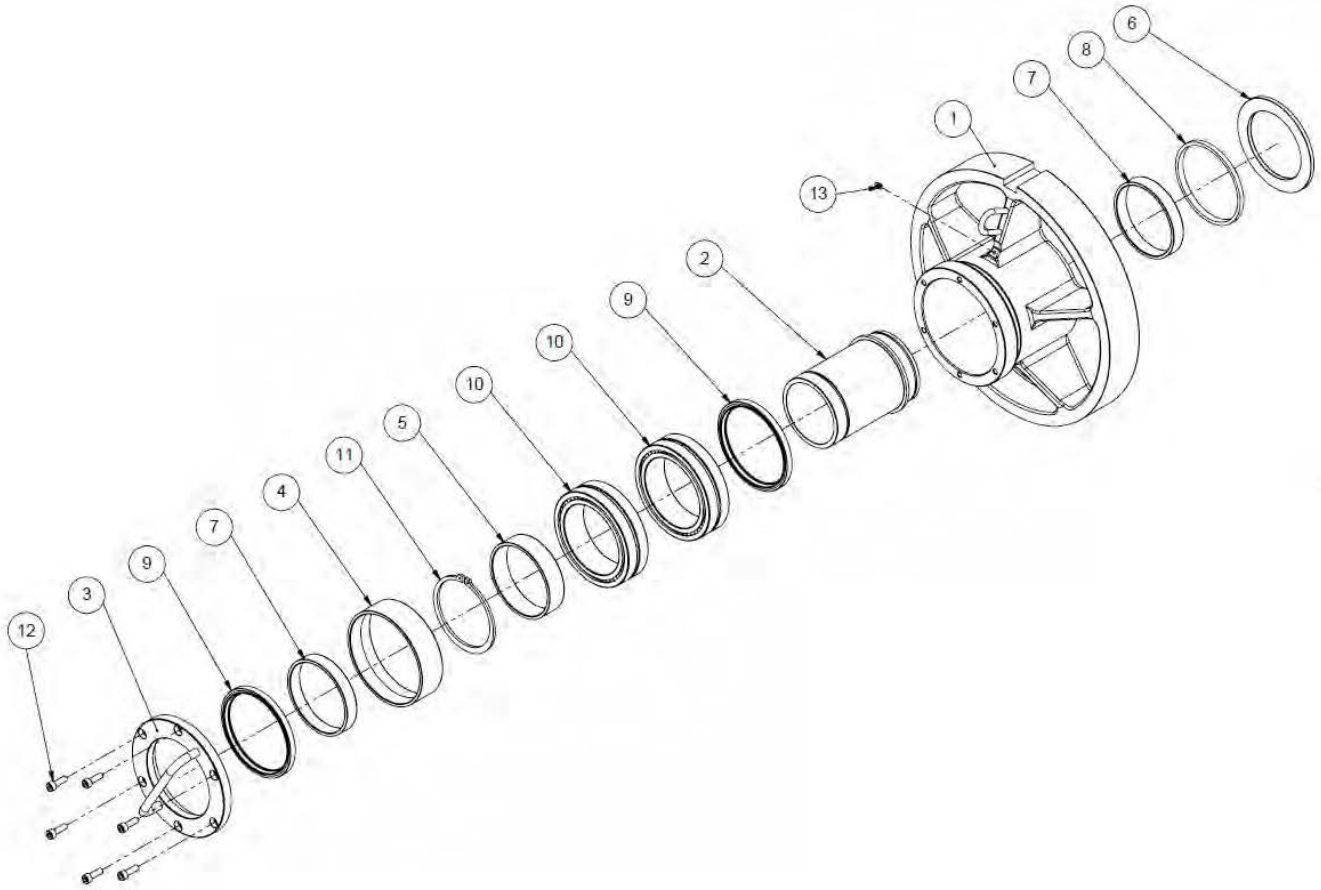

## Wolfking® / CFS® / GEA® / Simo® Grinder Parts - Pilot bearing (Cont.)

Parts List for Closed Pilot Bearing, Part Number 5000404247  / 404247  Part 1 of 4)

Machine Type	Pos. No.	Description	Qty.	Part Number
Wolfking® C.400-UNI Wolfking® C.400-UNI-HD Wolfking® C.400-2T70 Wolfking® B.400-UNI Wolfking® B.400-UNI-HD Wolfking® BB.400 Wolfking® BF.400 Wolfking® BMF.400 CFS® MaxiGrind 400 CFS® MaxiGrind 400 HD CFS® ChunkMaster400 GEA® MaxiGrind 400 GEA® MaxiGrind 400 HD	1	Bearing housing assembly	1	5000407197 407197
Wolfking® C.400-UNI Wolfking® C.400-UNI-HD Wolfking® C.400-2T70 Wolfking® B.400-UNI Wolfking® B.400-UNI-HD Wolfking® BB.400 Wolfking® BF.400 Wolfking® BMF.400 CFS® MaxiGrind 400 CFS® MaxiGrind 400 HD CFS® ChunkMaster400 GEA® MaxiGrind 400 GEA® MaxiGrind 400 HD	2	Hollow shaft	1	5000405063 405063
Wolfking® C.400-UNI Wolfking® C.400-UNI-HD Wolfking® C.400-2T70 Wolfking® B.400-UNI Wolfking® B.400-UNI-HD Wolfking® BB.400 Wolfking® BF.400 Wolfking® BMF.400 CFS® MaxiGrind 400 CFS® MaxiGrind 400 HD CFS® ChunkMaster400 GEA® MaxiGrind 400 GEA® MaxiGrind 400 HD	3	Cap	1	5000405462 405462
Wolfking® C.400-UNI Wolfking® C.400-UNI-HD Wolfking® C.400-2T70 Wolfking® B.400-UNI Wolfking® B.400-UNI-HD Wolfking® BB.400 Wolfking® BF.400 Wolfking® BMF.400 CFS® MaxiGrind 400 CFS® MaxiGrind 400 HD CFS® ChunkMaster400 GEA® MaxiGrind 400 GEA® MaxiGrind 400 HD	4	Wear ring	1	5000405439 405439

HD = Heavy Duty



Follow us on LinkedIn



Follow us on Facebook

## Wolfking® / CFS® / GEA® / Simo® Grinder Parts - Pilot Bearing (Cont.)

### Parts List for Closed Pilot Bearing, Part Number 5000404247 ✓ / 404247 ✓ (Part 2 of 4)

Machine Type	Pos. No.	Description	Qty.	Part Number
CFS® MaxiGrind 400 CFS® MaxiGrind 400 HD CFS® ChunkMaster 400 GEA® MaxiGrind 400 GEA® MaxiGrind 400 HD	4 (cont.)	Wear ring	1	5000405439 405439
Wolfking® C.400-UNI Wolfking® C.400-UNI-HD Wolfking® C.400-2T70 Wolfking® B.400-UNI Wolfking® B.400-UNI-HD Wolfking® BB.400 Wolfking® BF.400 Wolfking® BMF.400 CFS® MaxiGrind 400 CFS® MaxiGrind 400 HD CFS® ChunkMaster400 GEA® MaxiGrind 400 GEA® MaxiGrind 400 HD	5	Bushing	1	5000405406 405406
Wolfking® C.400-UNI Wolfking® C.400-UNI-HD Wolfking® C.400-2T70 Wolfking® B.400-UNI Wolfking® B.400-UNI-HD Wolfking® BB.400 Wolfking® BF.400 Wolfking® BMF.400 CFS® MaxiGrind 400 CFS® MaxiGrind 400 HD CFS® ChunkMaster400 GEA® MaxiGrind 400 GEA® MaxiGrind 400 HD	6	Lock ring	1	5000405408 405408
Wolfking® C.400-UNI Wolfking® C.400-UNI-HD Wolfking® C.400-2T70 Wolfking® B.400-UNI Wolfking® B.400-UNI-HD Wolfking® BB.400 Wolfking® BF.400 Wolfking® BMF.400 CFS® MaxiGrind 400 CFS® MaxiGrind 400 HD CFS® ChunkMaster400 GEA® MaxiGrind 400 GEA® MaxiGrind 400 HD	7	Inner ring for bushing	1	5000405407 405407
Wolfking® C.400-UNI Wolfking® C.400-UNI-HD Wolfking® C.400-2T70	8	Seal	1	5000405397 405397

HD = Heavy Duty

### Wolfking® / CFS® / GEA® / Simo® Grinder Parts - Pilot bearing (Cont.)

#### Parts List for Closed Pilot Bearing, Part Number 5000404247 / 404247 (Part 3 of 4)

Machine Type	Pos. No.	Description	Qty.	Part Number
Wolfking® B.400-UNI Wolfking® B.400-UNI-HD Wolfking® BB.400 Wolfking® BF.400 Wolfking® BMF.400 CFS® MaxiGrind 400 CFS® MaxiGrind 400 HD CFS® ChunkMaster400 GEA® MaxiGrind 400 GEA® MaxiGrind 400 HD	8 (cont.)	Seal	1	5000405397 405397
Wolfking® C.400-UNI Wolfking® C.400-UNI-HD Wolfking® C.400-2T70 Wolfking® B.400-UNI Wolfking® B.400-UNI-HD Wolfking® BB.400 Wolfking® BF.400 Wolfking® BMF.400 CFS® MaxiGrind 400 CFS® MaxiGrind 400 HD CFS® ChunkMaster400 GEA® MaxiGrind 400 GEA® MaxiGrind 400 HD	9	Oil seal ring	1	5000415475 415475
Wolfking® C.400-UNI Wolfking® C.400-UNI-HD Wolfking® C.400-2T70 Wolfking® B.400-UNI Wolfking® B.400-UNI-HD Wolfking® BB.400 Wolfking® BF.400 Wolfking® BMF.400 CFS® MaxiGrind 400 CFS® MaxiGrind 400 HD CFS® ChunkMaster400 GEA® MaxiGrind 400 GEA® MaxiGrind 400 HD	10	Cylindrical roller bearing	1	5000405062 405062
Wolfking® C.400-UNI Wolfking® C.400-UNI-HD Wolfking® C.400-2T70 Wolfking® B.400-UNI Wolfking® B.400-UNI-HD Wolfking® BB.400 Wolfking® BF.400 Wolfking® BMF.400 CFS® MaxiGrind 400 CFS® MaxiGrind 400 HD CFS® ChunkMaster400 GEA® MaxiGrind 400 GEA® MaxiGrind 400 HD	11	Lock ring	1	5000024849 24849

HD = Heavy Duty

## Wolfking® / CFS® / GEA® / Simo® Grinder Parts - Pilot Bearing (Cont.)

### Parts List for Closed Pilot Bearing, Part Number 5000404247 / 404247 (Part 4 of 4)

Machine Type	Pos. No.	Description	Qty.	Part Number
Wolfking® B.400-UNI Wolfking® B.400-UNI-HD Wolfking® BB.400 Wolfking® BF.400 Wolfking® BMF.400 CFS® MaxiGrind 400 CFS® MaxiGrind 400 HD CFS® ChunkMaster400 GEA® MaxiGrind 400 GEA® MaxiGrind 400 HD	12	Head screw	6	5000022620 22620
Wolfking® B.400-UNI Wolfking® B.400-UNI-HD Wolfking® BB.400 Wolfking® BF.400 Wolfking® BMF.400 CFS® MaxiGrind 400 CFS® MaxiGrind 400 HD CFS® ChunkMaster400 GEA® MaxiGrind 400 GEA® MaxiGrind 400 HD	13	Lubricating nipple	1	5000025405 25405

HD = Heavy Duty





Follow us on LinkedIn



Follow us on Facebook



## Wolfking® / CFS® / GEA® / Simo® Grinder Parts - Screw Cap

Machine Type	Description	Part Number
Wolfking® C.160-UNI Wolfking® C.200-UNI CFS® UniGrind160 CFS® UniGrind200 GEA® UniGrind160 GEA® UniGrind200	Screw cap Ø160/Ø200, stainless steel	30827
Wolfking® C.160-UNI Wolfking® C.200-UNI CFS® UniGrind160 CFS® UniGrind200 GEA® UniGrind160 GEA® UniGrind200	Screw cap Ø160/Ø200, mild steel	30829
Wolfking® C.250-UNI CFS® UniGrind 250 GEA® UniGrind 250	Screw cap Ø250, stainless steel	5000030897 30897
Wolfking® C.300-UNI Wolfking® C.300 Frozen Block Grinder	Screw cap Ø300, stainless steel, for Frozen Block Grinder	5000035882 35882
Wolfking® C.400-UNI Wolfking® C.400-UNI- UNI-HD Wolfking® C.400-2T70 Wolfking® B.400-UNI Wolfking® B.400-UNI-HD Wolfking® BB.400 Wolfking® BF.400 Wolfking® BMF.400 CFS® MaxiGrind 400 CFS® MaxiGrind 400 HD CFS® ChunkMaster400 GEA® MaxiGrind 400 GEA® MaxiGrind 400 HD	Screw cap Ø400 with thread, stainless steel	5000030690 30690



HD = Heavy Duty

## Wolfking® / CFS® / GEA® Grinder Parts - Screw Cap (Cont.)



Screw cap Ø400,  
part number 5000030690 /30690 



Screw cap secondary,  
part number 5000030698 /30698-304 

## Wolfking® / CFS® / GEA® Grinder Parts - Pulley

Description	Part Number
Pulley 260/75mm M24 taper lock	5000302332 302332
Pulley 24M 180, bore Ø75	5000302331 302331
Pulley 24M 630	5000023842 23842
Pulley 32L 400	5000023819 23819
Pulley 24M	6409-2 



Pulley 24M 630,  
part number 5000023842 /  
23842





Follow us on LinkedIn







Follow us on Facebook





## Wolfking® / CFS® / GEA® / Krämer & Grebe® / Simo® Grinder Parts - Poly-V Belt

Description	Part Number
Poly-V belt 1185 M24	5000024048 24048
Poly-V belt 1060 M24	5000024047 24047
Poly-V belt 990 M24, 2.515 mm	5000024046 <input checked="" type="checkbox"/> 24046 <input checked="" type="checkbox"/>
Poly-V belt 915 L32	5000024028 24028
Poly-V belt 880 L32	5000024027 24027
Poly-V belt 815 L32	5000024022 24022



### Wolfking® / CFS® / GEA® / Krämer & Grebe® / Simo® Grinder Parts - Worm/Auger (Cont.)

Machine Type	Description	Part Number	A mm	B mm	C mm	D mm	E mm	F mm	G mm	H mm	I mm	Worm Pin Part Number
Wolfking® TMIG-UNI-L CFS® TSMIG-UNI-L GEA® TSMIG-UNI-L	Worm Ø225, stainless steel, glass bead peened for TSMIG-UNI-L	5000038742  38742 	150	45	105	32	32	154		1017	1017	
Wolfking® TSMIG-UNI-M CFS® TSMIG-UNI-M GEA® TSMIG-UNI-M	Worm Ø225, stainless steel, glass bead peened for TSMIG-UNI-M	5000038755  38755 						154			872.5	

Machine Type	Description	Part Number	A mm	B mm	C mm	D mm	E mm	F mm	G mm	H mm	I mm	Worm Pin Part Number
Wolfking® C.250-UNI-S CFS® UniGrind250 GEA® UniGrind250	Worm Ø250-S, stainless steel, glass bead peened for C.250-UNI and SFG models with same grinder unit	5000030053  30053 	233	80	153	32	42	192		1082	929	500003002  30024  5000322971  322971 
Wolfking® C.250-UNI CFS® UniGrind 250 GEA® UniGrind 250	Worm Ø250-S, stainless steel, glass bead peened for TSMG/250-UNI and HC.250-UNI	5000030178  30178 										
Wolfking® C.250-UNI CFS® UniGrind250 GEA® UniGrind25	Worm Ø250-S, stainless steel, glass bead peened for C.250-UNI with CFD and SFG models with same grinder unit	5000030303  30303 	178	68	110	70	78	192		1026.6	890	5000030228  30228 
Wolfking® C.250-UNI CFS® UniGrind250 GEA® UniGrind250	Worm Ø250-L, stainless steel, glass bead peened for TSMG/250-UNI with CFD	5000030183  30183 						192			1033	5000030228  30228 
Wolfking® C.250-UNI CFS® UniGrind250 GEA® UniGrind250	Worm Ø250-L, mild steel, glass bead peened for TSMG/250-UNI with CFD	5000030182  30182 						192			1033	5000030228  30228 
Wolfking® C.250-UNI CFS® UniGrind250 GEA® UniGrind250	Worm Ø250-L, stainless steel, glass bead peened for C.250-UNI and SFG models with same grinder unit	5000030186  30186 	233	80	153	32	42	192		1342	1189	5000030024  30024  5000322971  322971 
Wolfking® C.250-UNI CFS® UniGrind250 GEA® UniGrind250	Worm Ø250-L, stainless steel, glass bead peened for TSMG/250-UNI and HC.250-UNI	5000030179  30179 	233	80	153	32	42	192		1200	1047	5000030024  30024  5000322971  322971 
Wolfking® C.250-UNI CFS® UniGrind250 GEA® UniGrind250	Worm Ø250-L, mild steel, glass bead peened for C.250-UNI and SFG models with same grinder unit	5000030052  30052 	233	80	153	32	42	192		1342	1189	5000030024  30024 
Wolfking® C.250-UNI CFS® UniGrind250 GEA® UniGrind250	Worm Ø250-L, stainless steel, glass bead peened for C.250-UNI with CFD and SFG models with same grinder unit	5000030302  30302 	178	68	110	70	78	192		1285	1175	5000030228  30228 
Wolfking® C.250-UNI CFS® UniGrind250 GEA® UniGrind250	Worm Ø250-L, mild steel, glass bead peened for TSMG/250-UNI with CFD	5000030182  30182 	178	68	110	70	78	192		1144	1034	5000030228  30228 
Wolfking® C.250-UNI CFS® UniGrind250 GEA® UniGrind250	Worm Ø250-UNI-S2T, spec. length	5000048257  48257 	233	80	153	32	42	192		885	732	5000030024  30024  5000322971  322971 

### Wolfking® / CFS® / GEA® / Krämer & Grebe® / Simo® Grinder Parts - Worm/Auger (Cont.)

Machine Type	Description	Part Number	A mm	B mm	C mm	D mm	E mm	F mm	G mm	H mm	I mm	Worm Pin Part Number
Wolfking® C.250-UNI CFS® UniGrind250 GEA® UniGrind250	Worm Ø250-S2T with cutting edge, mild steel, glass bead peened for C.250-UNI and SFG models with same grinder unit	5000030189 <input checked="" type="checkbox"/> 30189 <input checked="" type="checkbox"/>	233	80	153	32	42	192		1032	979	5000030019 5000030024
Wolfking® C.250-UNI CFS® UniGrind250 GEA® UniGrind250	Worm Ø250-S2T with cutting edge, stainless steel, glass bead peened for C.250-UNI and SFG models with same grinder unit	5000030551 <input checked="" type="checkbox"/> 30551 <input checked="" type="checkbox"/>	233	80	153	32	42	147 192		1032	879	5000030024 <input checked="" type="checkbox"/> 30024 <input checked="" type="checkbox"/> 5000322971 <input checked="" type="checkbox"/> 322971 <input checked="" type="checkbox"/>
Wolfking® C.250-UNI CFS® UniGrind250 GEA® UniGrind250	Worm Ø250-S2T with cutting edge, mild steel, glass bead peened for C.250-UNI and SFG models, with same grinder unit	5000030019 <input checked="" type="checkbox"/> 30019 <input checked="" type="checkbox"/>	233	80	153	32	42	147 192	147	1032	879	5000030024

















Machine Type	Description	Part Number	A mm	B mm	C mm	D mm	E mm	F mm	G mm	H mm	I mm	Worm Pin Part Number
Wolfking® C.300 Frozen Block Grinder	Worm for Ø300 FBG, stainless steel	5000037327 <input checked="" type="checkbox"/> 37327 <input checked="" type="checkbox"/>	295	150	145	70	72	244		1188	1043	5000037328 37328
Wolfking® C.300 Frozen Block Grinder	Worm Ø300, mild steel, glass bead peened for C.300 Frozen Block Grinder	5000037329 <input checked="" type="checkbox"/> 37329 <input checked="" type="checkbox"/>	295	150	145	70	72	244		1188	1043	37328 <input checked="" type="checkbox"/> 37328 <input checked="" type="checkbox"/>



Machine Type	Description	Part Number	A mm	B mm	C mm	D mm	E mm	F mm	G mm	H mm	I mm	Worm Pin Part Number
Wolfking® C.400-UNI Wolfking® B.400-UNI CFS® MaxiGrind 400 GEA® MaxiGrind 400	Worm Ø400-S, mild steel, glass bead peened for B.400-UNI and C.400-UNI/HD	5000031196 <input checked="" type="checkbox"/> 31196 <input checked="" type="checkbox"/>	370	150	220	65	96	352 308		1861.5	1641.5	5000309599
Wolfking® C.400-UNI-HD Wolfking® B.400-UNI-HD CFS® MaxiGrind 400 HD CFS® ChunkMaster 400 GEA® MaxiGrind 400 GEA® MaxiGrind 400 HD	Worm Ø400-S, stainless steel, glass bead peened for B.400-UNI and C.400-UNI/HD	5000031197 <input checked="" type="checkbox"/> 31197 <input checked="" type="checkbox"/>	370	150	220	65	96	352 308		1861.5	1641.5	5000309599
Wolfking® C.400-UNI CFS® MaxiGrind 400	Worm Ø400-S, mild steel, glass bead peened for C.400-UNI	5000031036 <input checked="" type="checkbox"/> 31036 <input checked="" type="checkbox"/>	405	150	255	65	96	308 352		1461.5	1241.5	309595
Wolfking® C.400-UNI CFS® MaxiGrind 400	Worm Ø400-S, stainless steel, glass bead peened for C.400-UNI	5000031035 <input checked="" type="checkbox"/> 31035 <input checked="" type="checkbox"/>	405	150	255	65	96	308 352		1461.5	1241.5	309595
Wolfking® C.400-UNI-HD Wolfking® B.400-UNI-HD CFS® MaxiGrind 400 CFS® MaxiGrind 400 HD GEA® MaxiGrind 400 GEA® MaxiGrind 400 HD	Worm Ø400-S2T, stainless steel, glass bead peened for C.400-UNI	5000031191 <input checked="" type="checkbox"/> 31191 <input checked="" type="checkbox"/>	370	150	220	65	96	354	225	1461.5	1241.5 1241.5	5000030229 30229
Wolfking® C.400-UNI-(S2T) CFS® MaxiGrind400 GEA® MaxiGrind400	Worm Ø400-S2T, mild steel, glass bead peened for C.400-UNI	5000031192 <input checked="" type="checkbox"/> 31192 <input checked="" type="checkbox"/>	405	150	255	65	96	255 354		1461.5	1241.5	5000030224 <input checked="" type="checkbox"/> 30224 <input checked="" type="checkbox"/>

HD=Heavy Duty

## Wolfking® / CFS® / GEA® / Krämer & Grebe® / Simo® Grinder Parts - Worm/Auger (Cont.)







Machine Type	Description	Part Number	A mm	B mm	C mm	D mm	E mm	F mm	G mm	H mm	I mm	Worm Pin Part Number
Wolfking® C.400-UNI-HD (S2T) Wolfking® B.400-UNI-HD (S2T) CFS® MaxiGrind 400HD GEA® MaxiGrind 400HD	Worm Ø400-S2T, mild steel, glass bead peened for B.400-UNI and C.400-UNI/HD with extra-long worm pin	5000309713  309713 	405	150	255	65	96	255 354		1896.5	1641.5	Extra-long worm pin 5000309599
Wolfking® C.400-UNI-HD (S2T) Wolfking® B.400-UNI-HD (S2T) CFS® MaxiGrind 400HD GEA® MaxiGrind 400HD	Worm Ø400-S2T, stainless steel, glass bead peened for B.400-UNI and C.400-UNI/HD – with extra-long worm pin	5000309709  309709 	405	150	255	65	96	255 354		1896.5	1641.5	Extra-long worm pin 5000309599
Wolfking® C.400-2T70 CFS® MaxiGrind400 GEA® MaxiGrind400	Worm Ø400 type A, mild steel, glass bead peened for C.400- 2T-70	5000030335  30335 	370	150	220	65	96	255 354		1451.5	1231.5	5000030229
Wolfking® C.400-2T70 CFS® MaxiGrind400 GEA® MaxiGrind400	Worm Ø400 (type B), stainless steel, glass bead peened for C.400-2T-70	5000030322  30322 	370	150	220	65	96	255 354		1451.5	1231.5	30229
Wolfking® BB.400	Worm Ø400 BB.400 High capacity	5000046647  46647 	285	100	140	83	85			1819	1679	5000046648
Wolfking® BF.400	Worm Ø400 BF.400 HD	5000045260  45260  500000364041  364041 	285	100	140	83	85	308 352		2021.5	1881.5	5000046648
Wolfking® C.400-UNI-HD (S2T) Wolfking® B.400-UNI-HD (S2T) CFS® MaxiGrind 400HD GEA® MaxiGrind 400HD	Worm Ø400-S2T, mild steel, glass bead peened for B.400- UNI and C.400-UNI/HD	5000031200  31200 	370	150	220	65	96	255 354		1861.5 1861.5	1641.5	5000030224 30224
Wolfking® C.400-UNI-HD (S2T) Wolfking® B.400-UNI-HD (S2T) CFS® MaxiGrind 400HD GEA® MaxiGrind 400HD	Worm Ø400-S2T, stainless steel, glass bead peened for B.400-UNI and C.400-UNI/HD	5000031201  31201 	405	150	255	65	96	255 354		1896.5	1641.5	5000030224 30224

Machine Type	Description	Part Number	A mm	B mm	C mm	D mm	E mm	F mm	G mm	H mm	I mm	Worm Pin Part Number
Krämer & Grebe® Winkel Wolf 200	Worm Ø200 for Winkel Wolf /WW200 mild steel	198D038M 			120			160		630.5	510.5	052B001T 

HD = Heavy Duty

## Wolfking® / CFS® / GEA® / Krämer & Grebe® / Simo® Grinder Parts - Worm/Auger (Cont.)

Machine Type	Description	Part Number	A mm	B mm	C mm	D mm	E mm	F mm	G mm	H mm	I mm	Worm Pin Part Number
CFS® PowerGrind 200 CFS® AutoGrind 200 GEA® PowerGrind 200 GEA® AutoGrind 200	Worm Ø200 for AutoGrind 200, fresh, stainless steel	3610522G02  3610522M01	235	70	165		40.4	160		865	700	36100S2501
CFS® PowerGrind 200 CFS® AutoGrind 200 GEA® PowerGrind 200 GEA® AutoGrind 200	Feeding worm Ø200 for AutoGrind 200	3610784K 						256		1210	1210	
CFS® PowerGrind 200 CFS® AutoGrind 200 GEA® PowerGrind 200 GEA® AutoGrind 200	Worm Ø200 for AutoGrind 200	3610833M	227	52	165	32	50	156		865	700	3610025501
CFS® PowerGrind 280 CFS® AutoGrind 280 GEA® PowerGrind 280 GEA® AutoGrind 280	Worm Ø280 for PowerGrind 280	412368 5000412368 5000403793	370	120	250	59	61	217		960	960	5000407090
CFS® PowerGrind 280 CFS® AutoGrind 280 GEA® PowerGrind 280 GEA® AutoGrind 280	Feeding worm Ø280 for PowerGrind 280	388852 5000388852 1000242336						350		1752	1752	
CFS® PowerGrind 280 CFS® AutoGrind 280 GEA® PowerGrind 280 GEA® AutoGrind 280	Feeding worm Ø280 for AutoGrind 280, fresh	3550847K 						345		1398	1398	
CFS® PowerGrind 280 CFS® AutoGrind 280 GEA® PowerGrind 280 GEA® AutoGrind 280	Grinding worm Ø280 for AutoGrind 280, special	3550848M 										

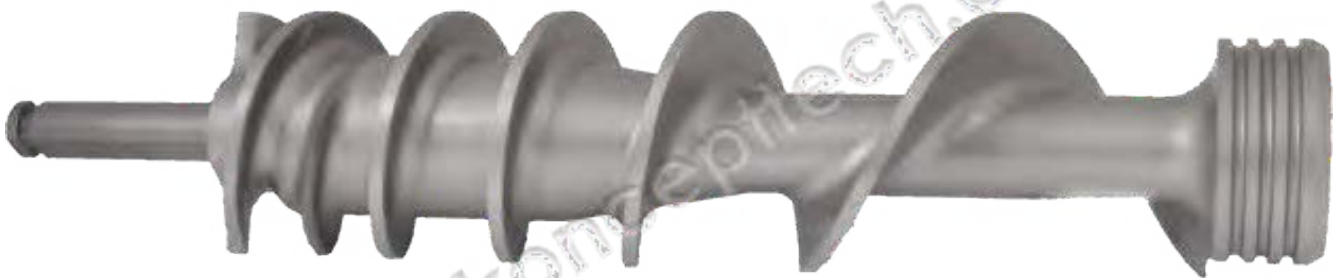





Worm for AutoGrind 200/AG200,  
3610522G02

### Wolfking® / CFS® / GEA® / Krämer & Grebe® / Simo® Grinder Parts - Worm Pin (Cont.)

**NOTE: For correct choice of worm/auger, please look at section for “Worm/Auger”**

Machine Type	Description	Part Number	A mm	B mm	C mm	D mm
Wolfking® Walian 140 CFS® Walian 140 GEA® Walian 140	Worm pin for worm Ø140	5000033562 33562	91	48	40	17

Machine Type	Description	Part Number	A mm	B mm	C mm	D mm
Wolfking® C.160-UNI CFS® UniGrind 160 GEA® UniGrind 160	Worm pin for worm Ø160-S	5000030377 30377	160	45	115	32.4
Wolfking® C.160-UNI CFS® UniGrind 160 GEA® UniGrind 160	Worm pin for worm Ø160-L for C.160-UNI as well as SFG and TSMG models with same grinder unit	5000030377  30377 	160	45	115	32.4

Machine Type	Description	Part Number	A mm	B mm	C mm	D mm
Wolfking® C.200-UNI CFS® UniGrind 200 GEA® UniGrind 200	Worm pin for worm Ø200-S for C.200-UNI as well as SFG and TSMG models with same grinder unit	500032933  32933 	165	45	120	32



Worm pin for worm Ø160-L, Ø250-S  
part number 5000030377 / 30377



Worm pin for worm Ø250-L, Ø250-S  
part number 5000030024 / 30024



Follow us on LinkedIn





Follow us on Facebook







## Wolfking® / CFS® / GEA® / Krämer & Grebe® / Simo® Grinder Parts - Worm Pin (Cont.)





Machine Type	Description	Part Number	A mm	B mm	C mm	D mm
Wolfking® C.250-UNI CFS® UniGrind 250 GEA® UniGrind 250	Worm pin for worm Ø250-S, stainless steel, glass bead peened for C.250-UNI and SFG models with same grinder unit	5000030024 <input checked="" type="checkbox"/> 30024 <input checked="" type="checkbox"/> 5000322971 <input checked="" type="checkbox"/> 322971 <input checked="" type="checkbox"/>	233	80	153	31.95
Wolfking® C.250-UNI CFS® UniGrind 250 GEA® UniGrind 250	Worm pin for worm Ø250-S, stainless steel, glass bead peened for C.250-UNI with CFD and SFG models with same grinder unit	5000030228 30228	178	68	110	70
Wolfking® C.250-UNI CFS® UniGrind 250 GEA® UniGrind 250	Worm pin for worm Ø250-L, stainless steel, glass bead peened for TSMG/250-UNI with CFD	5000030228 <input checked="" type="checkbox"/> 30228 <input checked="" type="checkbox"/>	178	68	110	70
Wolfking® C.250-UNI CFS® UniGrind 250 GEA® UniGrind 250	Worm pin for worm Ø250-L, stainless steel, glass bead peened for C.250-UNI and SFG models with same grinder unit	5000030024 <input checked="" type="checkbox"/> 30024 <input checked="" type="checkbox"/> 5000322971 <input checked="" type="checkbox"/> 322971 <input checked="" type="checkbox"/>	233	80	153	31.95
Wolfking® C.250-UNI CFS® UniGrind 250 GEA® UniGrind 250	Worm pin for worm Ø250-L, stainless steel, glass bead peened for TSMG/250-UNI and HC.250-UNI	5000030024 <input checked="" type="checkbox"/> 30024 <input checked="" type="checkbox"/> 5000322971 <input checked="" type="checkbox"/> 322971 <input checked="" type="checkbox"/>	233	80	153	31.95
Wolfking® C.250-UNI CFS® UniGrind 250 GEA® UniGrind 250	Worm pin for worm Ø250-L, mild steel, glass bead peened for C.250-UNI and SFG models with same grinder unit	5000030024 <input checked="" type="checkbox"/> 30024 <input checked="" type="checkbox"/>	233	80	153	31.95
Wolfking® C.250-UNI CFS® UniGrind 250 GEA® UniGrind 250	Worm pin for worm Ø250-L, stainless steel, glass bead peened for C.250-UNI with CFD and SFG models with same grinder unit	5000030228 <input checked="" type="checkbox"/> 30228 <input checked="" type="checkbox"/>	178	68	110	70
Wolfking® C.250-UNI CFS® UniGrind 250 GEA® UniGrind 250	Worm pin for worm Ø250-L, mild steel, glass bead peened for TSMG/250-UNI with CFD	5000030228 <input checked="" type="checkbox"/> 30228 <input checked="" type="checkbox"/>	178	68	110	70
Wolfking® C.250-UNI CFS® UniGrind 250 GEA® UniGrind 250	Worm pin for worm Ø250- UNI-S2T, spec. length	5000030024 <input checked="" type="checkbox"/> 30024 <input checked="" type="checkbox"/> 5000322971 <input checked="" type="checkbox"/> 322971 <input checked="" type="checkbox"/>	233	80	153	31.95
Wolfking® C.250-UNI CFS® UniGrind 250 GEA® UniGrind 250	Worm pin for worm Ø250-S2T with cutting edge, stainless steel, glass bead peened for C.250-UNI and SFG models with same grinder unit	5000030024 <input checked="" type="checkbox"/> 30024 <input checked="" type="checkbox"/> 5000322971 <input checked="" type="checkbox"/> 322971 <input checked="" type="checkbox"/>	233	80	153	31.95



## Wolfking® / CFS® / GEA® / Krämer & Grebe® / Simo® Grinder Parts - Worm Pin (Cont.)

Machine Type	Description	Part Number	A mm	B mm	C mm	D mm
Wolfking® C.300 Frozen Block Grinder	Worm pin for worm for Ø300 FBG, stainless steel	5000037328  37328 	295	150	145	70
Wolfking® C.300 Frozen Block Grinder	Worm pin for worm Ø300, mild steel, glass bead peened for C.300 Frozen Block Grinder	5000037328  37328 	295	150	145	70

Machine Type	Description	Part Number	A mm	B mm	C mm	D mm
Wolfking® C.400-UNI CFS® MaxiGrind 400	Worm pin for worm Ø400-S, mild steel, glass bead peened for C.400-UNI	5000030224  30224 	370	150	220	65
Wolfking® C.400-UNI CFS® MaxiGrind 400	Worm pin for worm Ø400-S, stainless steel, glass bead peened for C.400-UNI	5000030224  30224 	370	150	220	65
Wolfking® C.400-UNI-HD Wolfking® B.400-UNI Wolfking® B.400-UNI-HD CFS® MaxiGrind 400 CFS® MaxiGrind 400 HD GEA® MaxiGrind 400 GEA® MaxiGrind 400 HD	Worm pin for worm Ø400-S2T, stainless steel, glass bead peened for C.400-UNI	5000030229 30229	370	150	220	65
Wolfking® C.400-UNI-(S2T) CFS® MaxiGrind 400 GEA® MaxiGrind 400	Worm pin for worm Ø400-S2T, mild steel, glass bead peened for C.400-UNI	5000030224  30224 	370	150	220	65

Machine Type	Description	Part Number	A mm	B mm	C mm	D mm
Wolfking® C.400-UNI-HD (S2T) Wolfking® B.400-UNI-HD (S2T) CFS® MaxiGrind 400 HD GEA® MaxiGrind 400 HD	Worm pin for worm Ø400-S2T, mild steel, glass bead peened for B.400-UNI and C.400-UNI/HD with extra- long wormpin	Extra-long worm pin	405	150	255	65
Wolfking® C.400-UNI-HD (S2T) Wolfking® B.400-UNI-HD (S2T) CFS® MaxiGrind 400 HD GEA® MaxiGrind 400 HD	Worm pin for worm Ø400-S2T, stainless steel, glass bead peened for B.400-UNI and C.400-UNI/HD – with extra-long worm pin	Extra-long worm pin	405	150	255	65
Wolfking® C.400-UNI-HD (S2T) Wolfking® B.400-UNI-HD (S2T) CFS® MaxiGrind 400 HD GEA® MaxiGrind 400 HD	Worm pin for worm Ø400-S2T, mild steel, glass bead peened for B.400-UNI and C.400-UNI/HD	5000030224  30224 	370	150	220	65
Wolfking® C.400-UNI-HD (S2T) Wolfking® B.400-UNI-HD (S2T) CFS® MaxiGrind 400 HD GEA® MaxiGrind 400 HD	Worm pin for worm Ø400-S2T, stainless steel, glass bead peened for B.400-UNI and C.400-UNI/HD	5000030224  30224 	370	150	220	65

HD = Heavy Duty

## Wolfking® / CFS® / GEA® / Krämer & Grebe® / Simo® Grinder Parts - Worm Pin (Cont.)

Machine Type	Description	Part Number	A mm	B mm	C mm	D mm
Krämer & Grebe® Winkel Wolf 200	Worm pin for worm Ø200 for Winkel Wolf/WW200 mild steel	052B001T 	227		120	32

Machine Type	Description	Part Number	A mm	B mm	C mm	D mm
CFS® PowerGrind 200 CFS® AutoGrind 200 GEA® PowerGrind 200 GEA® AutoGrind 200	Worm pin for worm Ø200 for AutoGrind 200, fresh, stainless steel	36100S2501 3610022501	227	62	165	50

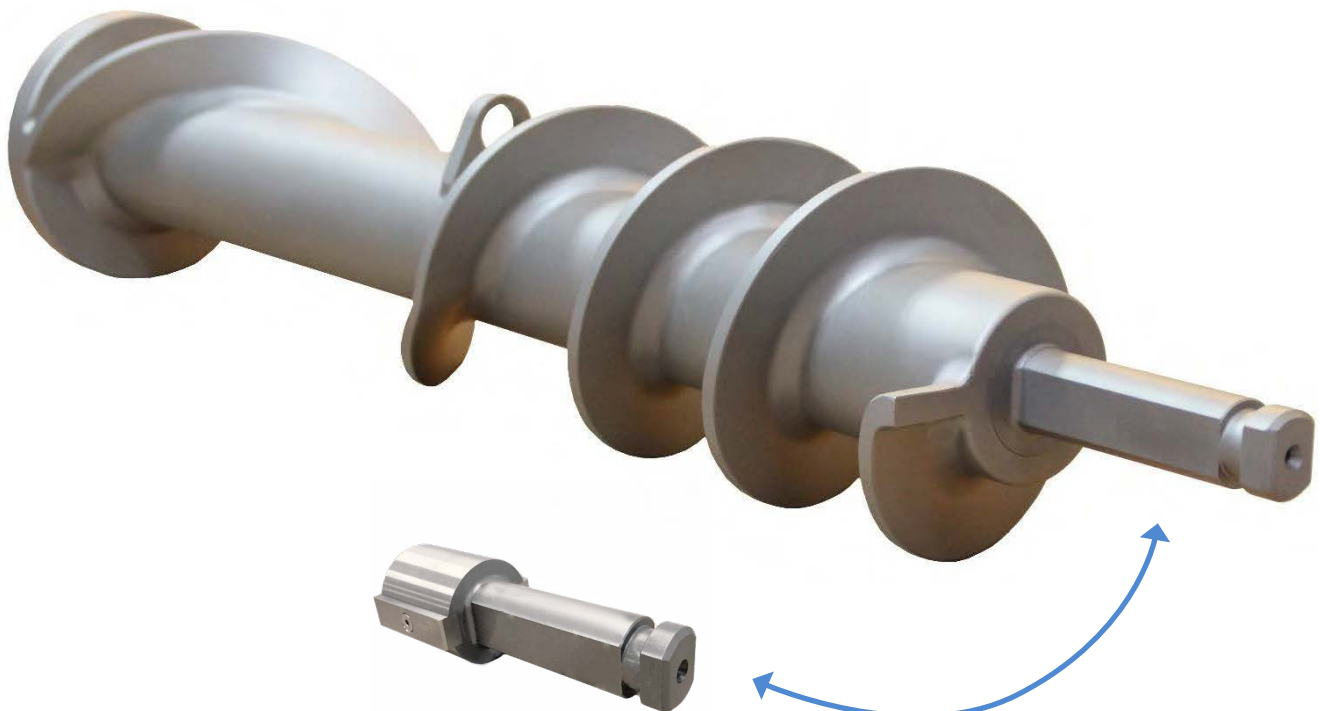

Worm pin Ø200  
part number 22501

## Wolfking® / CFS® / GEA® / Krämer & Grebe® / Simo® Grinder Parts - Flange w/Square Hole

Machine Type	Description	Part Number
Wolfking® C.250- UNI CFS® UniGrind 250 GEA® UniGrind 250	Flange with square hole for worms/ augers, stainless steel	5000030167 <input checked="" type="checkbox"/> 30167 <input checked="" type="checkbox"/>



Worm for Winkel Wolf200/WW200,  
198D038M



Follow us on LinkedIn



Follow us on Facebook







## Wolfking® / CFS® / GEA® Grinder Parts - Lining

Machine Type	Description	Part Number
Wolfking® C.160-UNI CFS® UniGrind 160 GEA® UniGrind 160	Lining Ø160-L, stainless steel	5000030681 30681
Wolfking® C.160-UNI CFS® UniGrind 160 GEA® UniGrind 160	Lining Ø160-S, stainless steel	5000033712 33712
Wolfking® C.160-UNI CFS® UniGrind 160 GEA® UniGrind 160	Lining Ø160-L, stainless steel	5000033713 33713

Machine Type	Description	Part Number
Wolfking® C.200-UNI CFS® UniGrind 200 GEA® UniGrind 200	Lining Ø200-L, stainless steel	5000030681 30681
Wolfking® C.200-UNI CFS® UniGrind 200 GEA® UniGrind 200	Lining Ø200-L, stainless steel	5000033712 33712
Wolfking® C.200-UNI CFS® UniGrind 200 GEA® UniGrind 200	Lining Ø200-L, stainless steel	5000033713 33713

Machine Type	Description	Part Number
Wolfking® TSMIG-UNI CFS® TSMIG-UNI GEA® TSMIG-UNI	Lining Ø225-L	500038743L 38743L
Wolfking® TSMIG-UNI CFS® TSMIG-UNI GEA® TSMIG-UNI	Lining Ø225-M, stainless steel	5000038756 38756
Wolfking® TSMIP	Lining Ø225-M, stainless steel	5000038756 38756

### Wolfking® / CFS® / GEA® Grinder Parts - Lining (Cont.)

Machine Type	Description	Part Number
Wolfking® C.250-UNI CFS® UniGrind 250 GEA® UniGrind 250	Lining Ø250-L, stainless steel	5000035292  35292 
Wolfking® C.250-UNI CFS® UniGrind 250 GEA® UniGrind 250	Lining Ø250-S, stainless steel	5000035293  35293 
Wolfking® C.250-UNI CFS® UniGrind 250 GEA® UniGrind 250	Lining Ø250-S2T, stainless steel	5000035294  35294 

Machine Type	Description	Part Number
Wolfking® C.400-UNI CFS® MaxiGrind 400 GEA® MaxiGrind 400	Lining Ø400-S, stainless steel	5000032452  32452 
Wolfking® C.400-UNI CFS® MaxiGrind 400 GEA® MaxiGrind 400	Lining Ø400-S2T, stainless steel	5000030647  30647 
Wolfking® BF.400-UNI-HD	Lining Ø400, stainless steel	5000049881  49881 
Wolfking® C.400-UNI-2T70 CFS® MaxiGrind 400 GEA® MaxiGrind 400	Knife housing/lining Ø400 (type A), stainless steel	5000030645 30645
Wolfking® C.400-UNI-2T70 CFS® MaxiGrind 400 GEA® MaxiGrind 400	Knife housing/lining Ø400 (type B), stainless steel	5000030646  30646 
Wolfking® C.400-UNI Wolfking® B.400-UNI CFS® MaxiGrind 400 GEA® MaxiGrind 400	Lining Ø400-S, mild steel	5000030650  30650 

HD = Heavy Duty

## Wolfking® / CFS® / GEA® Grinder Parts - Lining (Cont.)

Machine Type	Description	Part Number
CFS® PowerGrind 200 CFS® AutoGrind 200 GEA® PowerGrind 200 GEA® AutoGrind 200	Lining Ø200	3610705 
CFS® PowerGrind 280 CFS® AutoGrind 280 GEA® PowerGrind 280 GEA® AutoGrind 280	Lining Ø280	3550841





Lining/knife housing for BB 400L,  
part number 5000030645 /30645











Lining for C.400,  
part number 5000032452 /  
32452

### Wolfking® / CFS® / GEA® Grinder Parts - Knife Housing



Machine Type	Description	Part Number
Wolfking® C.160-UNI CFS® UniGrind 160 GEA® UniGrind 160	Knife housing, stainless steel	30441









Machine Type	Description	Part Number
Wolfking® C.200-UNI CFS® UniGrind 200 GEA® UniGrind 200	Knife housing, stainless steel	5000030779  30779 







Machine Type	Description	Part Number
Wolfking® TSMIG-UNI CFS® TSMIG-UNI GEA® TSMIG-UNI	Knife housing Ø225 for BES TS-MIG/225, stainless steel	5000038744  38744 

Machine Type	Description	Part Number
Wolfking® C.250-UNI CFS® UniGrind 250 GEA® UniGrind 250	Knife housing	5000030443  30443 
Wolfking® C.250-UNI CFS® UniGrind 250 GEA® UniGrind 250	Knife housing for BES (model 82), stainless steel	5000030205  30205 
Wolfking® C.250-UNI CFS® UniGrind 250 GEA® UniGrind 250	Knife housing/lining, stainless steel with water jacket	5000038387  38387 

## Wolfking® / CFS® / GEA® Grinder Parts - Knife Housing (Cont.)



Machine Type	Description	Part Number
Wolfking® C.400-UNI-2T70 CFS® MaxiGrind 400 GEA® MaxiGrind 400	Knife housing/lining (type A), stainless steel	5000030645 30645
Wolfking® C.400-UNI-2T70 CFS® MaxiGrind 400 GEA® MaxiGrind 400	Knife housing/lining (type B), stainless steel	5000030646  30646 

Machine Type	Description	Part Number
Wolfking® C.300-UNI	Knife housing	5000036147  36147  5000309382  309382 
Wolfking® C.300-UNI	Knife housing/lining, stainless steel with water jacket	5000038387  38387 
Wolfking® C.300 Frozen Block Grinder	Knife housing	5000035881  35881 





Machine Type	Description	Part Number
Wolfking® C.400-UNI CFS® MaxiGrind 400 GEA® MaxiGrind 400	Knife housing, trapeze thread, stainless steel	5000030420  30420 
Wolfking® C.400-UNI-2T70 CFS® MaxiGrind 400 GEA® MaxiGrind 400	Knife housing/lining	5000030646  30646 
Wolfking® C.400-UNI Wolfking® B.400-UNI CFS® MaxiGrind 400 CFS® ChunkMaster 400 GEA® MaxiGrind 400	Knife housing, trapeze thread, mild steel	5000031032  31032 



## Wolfking® / CFS® / GEA® Grinder Parts - Knife Housing (Cont.)

Machine Type	Description	Part Number
Wolfking® C.250-UNI	Key for knife housing	5000030913 
CFS® UniGrind 250		30913 
GEA® UniGrind 250		

Machine Type	Description	Part Number
Wolfking® C.300 Frozen Block Grinder	Key for knife housing	5000030910 30910

Machine Type	Description	Part Number
Wolfking® C.400-UNI MD82	Key for knife housing	5000030725 
CFS® MaxiGrind 400		30725 
Wolfking® C.400-UNI MD82	Parallel key (knife housing and lining)	5000030724 
CFS® MaxiGrind 400		30724 



Knife housing C.400, part number  
5000030420 / 30420

## Wolfking® / CFS® / GEA® Grinder Parts - Gear Box Parts



Gear box for C.400/B.400,  
part number 5000302421 / 302421



Gear box for C.250,  
part number 5000045087 / 45087



Gear box for C.160/C.200,  
part number 5000030860 / 30860



Drive shaft for C.400/B.400 gear box, (worm end),  
part number 5000046119 / 46119



Drive shaft for C.250 gear box, (worm end),  
part number 5000030944 / 30944



Drive shaft for C.160/C.200 gear box (worm end),  
part number 5000038740 / 38740



Pinion shaft for C.400/B.400 gear box,  
part number 5000037647 / 37647



Pinion shaft for C.250 gear box,  
part number 5000030943 / 30943



Pinion shaft for C.160/C.200 gear box,  
part number 5000030286 / 30286 / 5000316489 / 316489



Shaft sealing for C.400/B.400 gear box,  
part number 5000308559 / 308559



Shaft sealing for C.250 gear box



PS seal for C.160/C.200 gear box



David Brown gear box for C.400/B.400-UNI HD,  
part number 5000010366 / 10366

## Wolfking® / CFS® / GEA® Grinder Parts - Gear Box Parts (Cont.)

Exploded View of Gear Unit, Part Number 5000302421 ✓ / 302421 ✓ (Part 1 of 2)

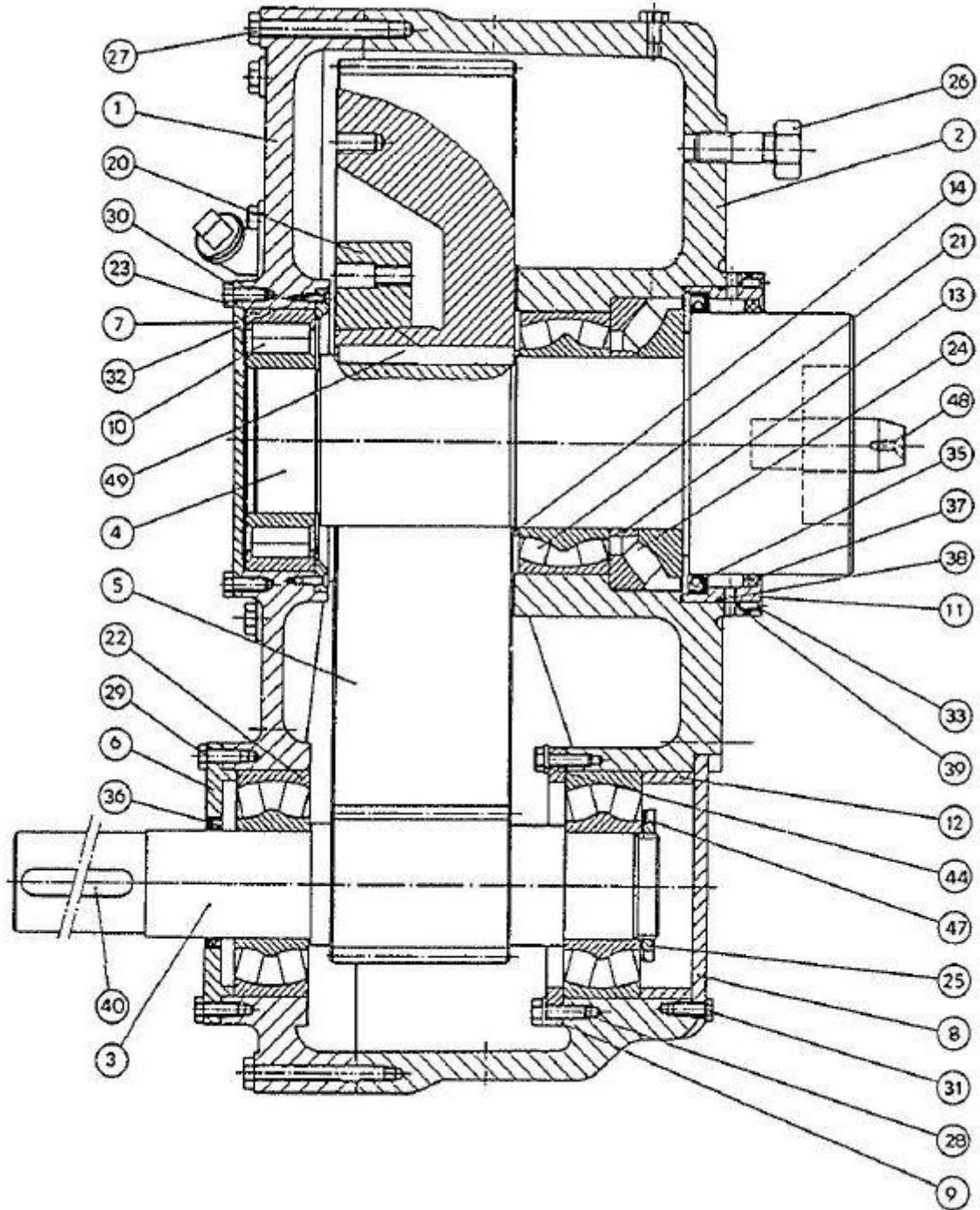

## Wolfking® / CFS® / GEA® Grinder Parts - Gear Box Parts (Cont.)

### Exploded View of Gear Unit, Part Number 5000302421 ✓ / 302421 ✓ (Part 2 of 2)

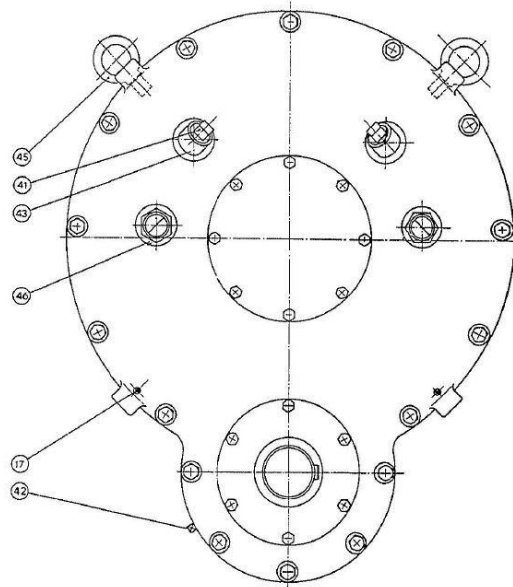

Machine Type	Description	Part Number
Wolfking® B.400-UNI Wolfking® B.400-UNI-HD Wolfking® BB.400-HD Wolfking® BF.400-HD	Gear 1:5.21, shaft $\varnothing 80$	5000302421 ✓ 302421 ✓
Wolfking® B.400-UNI Wolfking® B.400-UNI-HD Wolfking® BB.400-HD Wolfking® BF.400-HD	Gear housing, belt pulley	5000046115 46115
Wolfking® B.400-UNI Wolfking® B.400-UNI-HD Wolfking® BB.400-HD Wolfking® BF.400-HD	Gear housing, worm/auger	5000302422 302422
Wolfking® B.400-UNI Wolfking® B.400-UNI-HD Wolfking® BB.400-HD Wolfking® BF.400-HD	Pinion shaft 19 teeth $\varnothing 80$	5000046635 46635
Wolfking® B.400-UNI Wolfking® B.400-UNI-HD Wolfking® BB.400-HD Wolfking® BF.400-HD	Drive shaft gear 5:2:1	5000046119 46119
Wolfking® B.400-UNI Wolfking® B.400-UNI-HD Wolfking® BB.400-HD Wolfking® BF.400-HD	Toothed wheel 99 teeth	5000037647 37647

HD = Heavy Duty



Follow us on LinkedIn



Follow us on Facebook

### Wolfking® / CFS® / GEA® Grinder Parts - Gear Box Parts (Cont.)

Machine Type	Description	Part Number
Wolfking® C.160-UNI Wolfking® C.200-UNI CFS® UniGrind 160 GEA® UniGrind 160	Gear 30/40 HP 3.2:1, shaft 045	500030860 30860 500316489 316489
Wolfking® C.160-UNI Wolfking® C.200-UNI CFS® UniGrind 160 GEA® UniGrind 160	Gear box 30 HP outer part	500030410 30410
Wolfking® C.160-UNI Wolfking® C.200-UNI CFS® UniGrind 160 GEA® UniGrind 160	Pinion shaft 14 teeth	500030286 30286
Wolfking® C.160-UNI Wolfking® C.200-UNI CFS® UniGrind 160 GEA® UniGrind 160	Drive shaft gear 3.2:1	500030245 30245
Wolfking® C.160-UNI Wolfking® C.200-UNI CFS® UniGrind 160 GEA® UniGrind 160	Square shaft without air (external) for drive shaft, part number 500030245/30245	5000315567 315567
Wolfking® C.160-UNI Wolfking® C.200-UNI CFS® UniGrind 160 GEA® UniGrind 160	Toothed wheel 45 teeth	500030295 30295
Wolfking® C.160-UNI Wolfking® C.200-UNI CFS® UniGrind 160 GEA® UniGrind 160	Square shaft without air (external) for drive shaft, part number 500030860/30860	500315568 315568
Wolfking® C.160-UNI Wolfking® C.200-UNI CFS® UniGrind 160 GEA® UniGrind 160	Bushing for gear	500030416 30416
Wolfking® C.160-UNI Wolfking® C.200-UNI CFS® UniGrind 160 GEA® UniGrind 160	Seal for gear	500315521



Follow us on LinkedIn





Follow us on Facebook

## Wolfking® / CFS® / GEA® Grinder Parts - Gear Box Parts (Cont.)

Machine Type	Description	Part Number
Wolfking® C.250-UNI (with CFD) CFS® UniGrind 250 GEA® UniGrind 250	Gear 75 HP 4.4:1, shaft 060	5000045087 45087
Wolfking® C.250-UNI (with CFD) CFS® UniGrind 250 GEA® UniGrind 250	Gear housing, internal part	5000035677 35677
Wolfking® C.250-UNI (with CFD) CFS® UniGrind 250 GEA® UniGrind 250	Gear housing, external part	5000030947 30947
Wolfking® C.250-UNI (with CFD) CFS® UniGrind 250 GEA® UniGrind 250	Pinion shaft 19 teeth	5000030943 30943
Wolfking® C.250-UNI (with CFD) CFS® UniGrind 250 GEA® UniGrind 250	Drive shaft	5000030944 30944
Wolfking® C.250-UNI (with CFD) CFS® UniGrind 250 GEA® UniGrind 250	Toothed wheel 84 teeth	5000030945 30945
Wolfking® C.250-UNI (with CFD) CFS® UniGrind 250 GEA® UniGrind 250	Sealing ring	304709
Wolfking® C.250-UNI (with CFD) CFS® UniGrind 250 GEA® UniGrind 250	Repair kit	wkgr900-250xrepkit

### Wolfking® / CFS® / GEA® Grinder Parts - Gear Box Parts (Cont.)

Machine Type	Description	Part Number
Wolfking® C.400-UNI Wolfking® B.400-UNI CFS® MaxiGrind 400 CFS® ChunkMaster 400 GEA® MaxiGrind 400	Gear 125 HP, 5.21:1, shaft Ø75 for max. 90 kW	5000030861  30861 
Wolfking® C.400-UNI Wolfking® B.400-UNI CFS® MaxiGrind 400 CFS® ChunkMaster 400 GEA® MaxiGrind 400	Gear housing, belt pulley	5000046115 46115
Wolfking® C.400-UNI Wolfking® B.400-UNI CFS® MaxiGrind 400 CFS® ChunkMaster 400 GEA® MaxiGrind 400	Gear housing, worm/auger	50000302422 302422
Wolfking® C.400-UNI Wolfking® B.400-UNI CFS® MaxiGrind 400 CFS® ChunkMaster 400 GEA® MaxiGrind 400	Pinion shaft 19 teeth Ø75	





Follow us on LinkedIn



Follow us on Facebook

## Wolfking® / CFS® / GEA® Grinder Parts - Gear Box Parts (Cont.)

Machine Type	Description	Part Number
Wolfking® C.400-UNI Wolfking® B.400-UNI CFS® MaxiGrind 400 CFS® ChunkMaster 400 GEA® MaxiGrind 400	Drive shaft gear 5:2:1	
Wolfking® C.400-UNI Wolfking® B.400-UNI CFS® MaxiGrind 400 CFS® ChunkMaster 400 GEA® MaxiGrind 400	Toothed wheel 99 teeth	
Wolfking® C.400-UNI Wolfking® B.400-UNI CFS® MaxiGrind 400 CFS® ChunkMaster 400 GEA® MaxiGrind 400	Shaft sealing	5000308559 308559
Wolfking® C.400-UNI Wolfking® B.400-UNI CFS® MaxiGrind 400 CFS® ChunkMaster 400 GEA® MaxiGrind 400	Repair kit for shaft sealing, part number 5000308559 / 308559	kit308559
Wolfking® C.400-UNI Wolfking® B.400-UNI CFS® MaxiGrind 400 CFS® ChunkMaster 400 GEA® MaxiGrind 400	O-rings for shaft sealing (one set = 2 pcs.)	708119
Wolfking® C.400-UNI Wolfking® B.400-UNI CFS® MaxiGrind 400 CFS® ChunkMaster 400 GEA® MaxiGrind 400	O-rings for shaft sealing (one set = 2 pcs.)	715022
Wolfking® C.400-UNI Wolfking® B.400-UNI CFS® MaxiGrind 400 CFS® ChunkMaster 400 GEA® MaxiGrind 400	Carbon ring for shaft sealing	715023
Wolfking® C.400-UNI Wolfking® B.400-UNI CFS® MaxiGrind 400 CFS® ChunkMaster 400 GEA® MaxiGrind 400	Polyethylene ring	715024





Follow us on LinkedIn



Follow us on Facebook

## Wolfking® / CFS® / GEA® Grinder Parts - Gear Box Parts (Cont.)

Machine Type	Description	Part Number
Wolfking® C.160-UNI Wolfking® C.200-UNI Wolfking® TSMIG/225	Gear 30 HP, with air connection	5000038738 38738 5000316470 316470
Wolfking® C.160-UNI Wolfking® C.200-UNI Wolfking® TSMIG/225	Pinion shaft 14 teeth	5000030286 30286
Wolfking® C.160-UNI Wolfking® C.200-UNI Wolfking® TSMIG/225	Bushing for gear	5000030416 30416
Wolfking® C.160-UNI Wolfking® C.200-UNI Wolfking® TSMIG/225	Output shaft	5000038740 38740
Wolfking® C.160-UNI Wolfking® C.200-UNI Wolfking® TSMIG/225	Oil seal ring BA902 60x80x10	5000023134 23134
Wolfking® C.160-UNI Wolfking® C.200-UNI Wolfking® TSMIG/225	Gear wheel 45 teeth	5000030295 30295

## Wolfking® / CFS® / GEA® Grinder Parts - Gear Box Parts (Cont.)

### Repair-/Rebuild Kit for Gear for Wolfking® C.400 Heavy Duty, Part Number 111-03

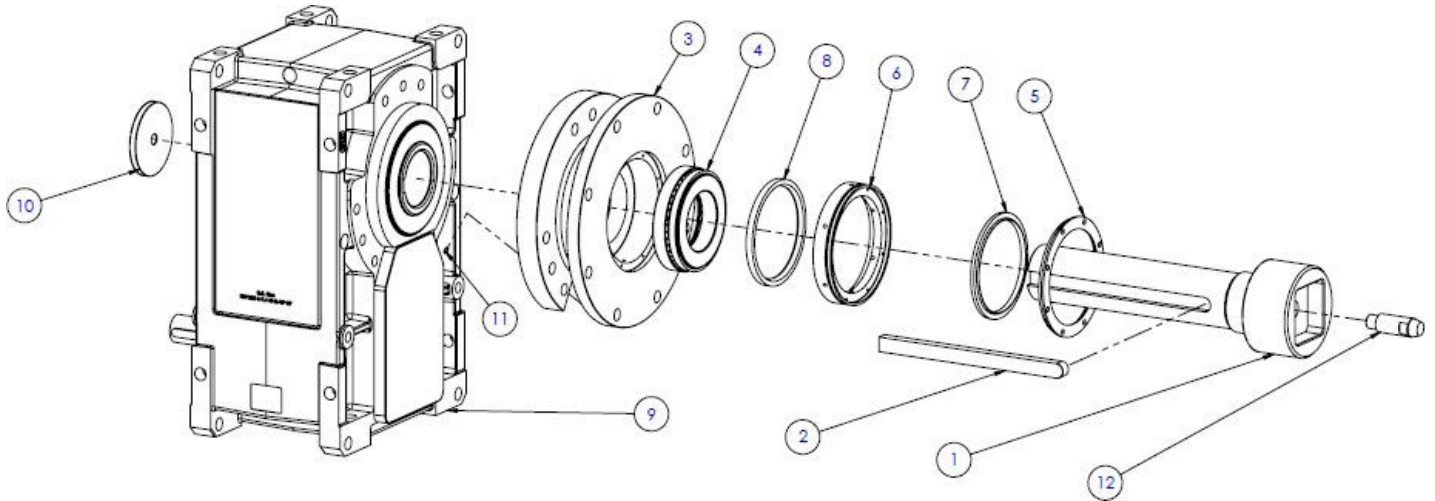

Pos. No.	Description	Part Number	Qty.
1	Drive shaft	111-02	1
2	Key	111-04	1
3	Adaptor	111-05	1
4	Bearing 29326 E	01-77	1
5	Inside cover for adaptor	111-06	1
6	Sealing housing for adaptor	111-07	1
7	Wiper PUR SA2H VU 200-230x8-12	01-382	1
8	Rotary shaft seal OA NBR-70 200-230-15	01-1051	1
9	O-ring Ø255x3 NB-70	01-1173	1
10	Gear box HDP1007.4HLLVPB7 i=7.4	01-569	1
11	Lock cap for gear	111-08	1

**For Quotation, Please Contact Koncept Tech ApS**  
**by phone: +45 70271410 and E-mail: parts@koncepttech.com**

## Wolfking® / CFS® / GEA® Grinder Parts - Gear Box Parts (Cont.)

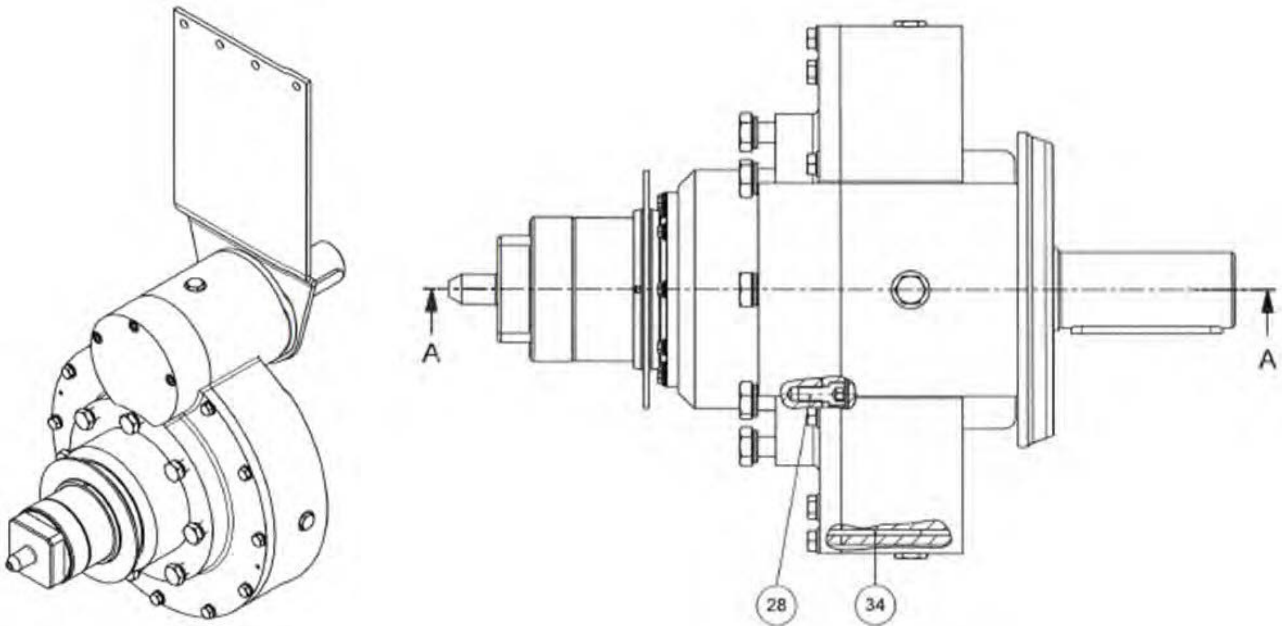

**Special Gear Box for C.250, Part Number 5000312879 ✓/312879 ✓**

Machine Type	Description	Part Number
Wolfking® C.250-UNI	Gear 75 HP 4.4:1, shaft Ø60	5000312879 ✓
Wolfking® C.250-UNI with CFD		312879 ✓
CFS® UniGrind 250		
GEA® UniGrind 250		

## Wolfking® / CFS® / GEA® Grinder Parts - Miscellaneous Electrical Parts

Description	Part Number
Temperature sensor pipe	5000014499 14499
Temperature amplifier	5000469955 496655
Temperature sensor	5000369708 369708
Safety relay 2NO+aux:1ss	5000200455 <input checked="" type="checkbox"/> 200455 <input checked="" type="checkbox"/>
Safety switch magnetic 10 m wire	5000682208 <input checked="" type="checkbox"/> 682208 <input checked="" type="checkbox"/>
Safety switch RFID 10 m wire	5000300332 300332
Ferrogard magnetic switch 10 m wire	5000367768 367768
Safety wire kit 20 m (tripwire, wire 20 m, spring)	otmm900-xSafetywirekit <input checked="" type="checkbox"/>



Temperature sensor,  
part number 5000369708 /  
369708

## Wolfking® / CFS® / GEA® Grinder Parts - Overview of Parts for Wolfking® C.250/300 UNI

### Exploded View of Wolfking® Grinder C.250/300-UNI

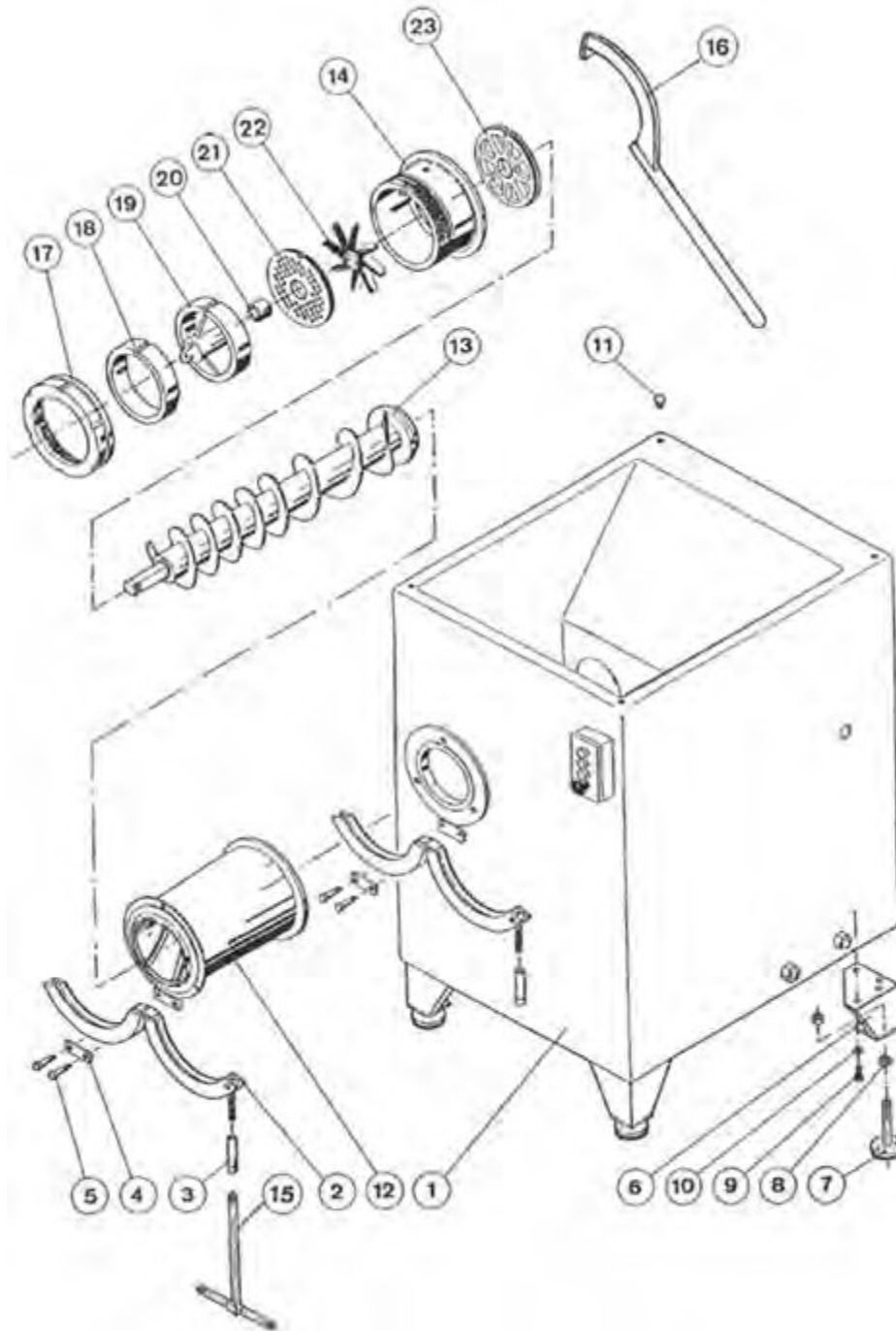



Follow us on LinkedIn

Follow us on Facebook



















## Wolfking® / CFS® / GEA® Grinder Parts - Parts List for Wolfking® C.250/300 UNI (Cont.)

### Parts List for Wolfking® Grinder C.250/300-UNI (Part 1 of 2)

Pos. No.	Description	Part Number	Qty.
02	Clamp	5000035330 35330	2
03	Nut for clamp	5000030396 30396	2
04	Retainer for clamp	5000035317 35317	2
05	Fitted bolt for clamp	5000022146 22146	4
06	Leg, H=180	5000030965 30965	4
07	Machine shoe	5000027874 27874	4
08	Nut, M24, stainless steel	5000022310 22310	8
09	Set screw, M12x25	5000022034 22034	16
10	Facet washer, M12	5000022707 22707	16
11	Dead end screw	5000030906 30906	4
12	Lining for C.250-L, stainless steel	5000035292 35292	1
12	Lining for C.250-S stainless steel	5000035293 35293	1
12	Lining for C.250-S2T, stainless steel	5000035294 35294	1
13	Worm/auger for C.250-L / UniGrind-L, stainless steel	5000030186 30186	1
13	Worm/auger for C.250-L / UniGrind-L, mild steel	5000030052 30052	1
13	Worm/auger for C.250-S / UniGrind-S, stainless steel	5000030053 30053	1
13	Worm/auger for C.250-S / UniGrind-S, mild steel	5000030021 30021	1
13	Worm/auger for C.250-S2T, stainless steel	5000030551 30551	1

## Wolfking® / CFS® / GEA® Grinder Parts - Parts List for Wolfking® C.250/300 UNI (Cont.)

### Parts List for Wolfking® Grinder C.250/300-UNI (Part 2 of 2)

Pos. No.	Description	Part Number	Qty.
13	Worm/auger for C.250-S2T, mild steel	5000030189 30189 5000030019  30019 	1
14	Knife housing	5000030443  30443 	1
15	Wrench key	5000026990 26990	1
16	Key for screw cap	5000030390 30390	1
17	Screw cap	5000030897  30897 	1
18	Retaining ring	5000030912 30912	1
19	Pilot bearing	5000031173  31173  5000030351  30351  5000036744  367446 	1
20	Nut for pilot bearing	5000030005  30005 	1
(20)	Roller bearing	5000031177  31177 	1
(20)	Steel bushing for pilot bearing with roller bearing, stainless steel	5000031246  31246 	1
21	Hole plate		1
22	Knife		1
23	Pre-cutter		1
24	Nut, M30, stainless steel	5000022311 22311	2
25	Washer, Ø50x30,5x3 mm, brass	5000023063 23063	4
26	Allen, MSP, M10x10	5000022540 22540	2
27	Fixed key	5000025679 25679	1

## Wolfking® / CFS® / GEA® Grinder Parts - View of Wolfking® C.400 UNI

### Exploded View of Wolfking® Grinder C.400-UNI

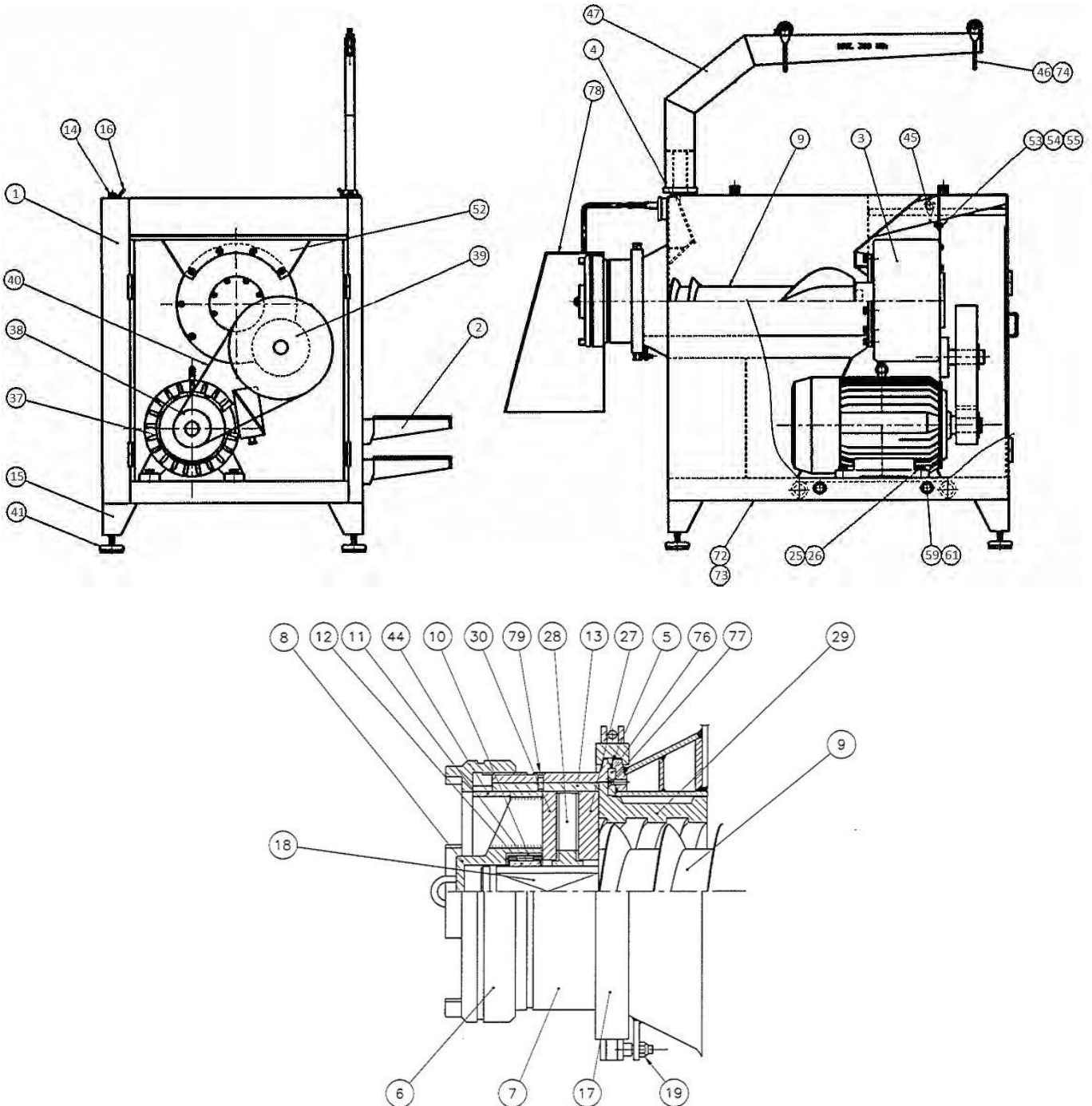



## Wolfking® / CFS® / GEA® Grinder Parts - Parts List for Wolfking® C.400 (Cont.)

### Parts List for Wolfking® Grinder C.400-UNI (Part 1 of 3)

Pos. No.	Description	Part Number	Qty.
02	Safety step	5000045927 45927	1
02	Safety step	5000047164 47164	1
03	Gear 125 HP	5000030861 30861	1
05	O-ring, Ø470x4.5, L=1478	5000045699 45699	1
06	Screw cap	5000030690 30690	1
07	Knife housing	5000030420 30420	1
08	Pilot bearing	5000032555 32555	1
09	Worm/auger for C.400-S, stainless steel	5000031035 31035	1
09	Worm/auger for C.400-S, mild steel	5000031036 31036	1
09	Worm/auger for C.400-S2T, mild steel	5000031192 31192	1
09	Worm/auger for C.400-2T70, stainless steel	5000031201 31201	1
09	Worm/auger for C.400-2T70, mild steel	5000031200 31200	1
10	Lining for pilot bearing, steel	5000032554 32554	1
11	Roller bearing for pilot bearing	5000032549 32549	1
12	Nut for pilot bearing	5000032551 32551	1
13	Key for knife housing	5000030725 30725	1
14	End screw	5000451954 451954	4
15	Leg	5000030965 30965	4
16	Lifting fitting	5000031038 31038	4

## Wolfgang® / CFS® / GEA® Grinder Parts - Parts List for Wolfgang® C.400 (Cont.)

### Parts List for Wolfgang® Grinder C.400-UNI (Part 2 of 3)

Pos. No.	Description	Part Number	Qty.
17	Clamp	5000031077 31077	1
18	Worm pin	5000030224 30224	1
24	Suspension washer for motor	5000355448 355448	4
25	Nut, M24, stainless steel	5000022310 22310	4
26	Bolt, M24x100, stainless steel	5000022180 22180	4
27	Pre-cutter		1
28	Knife		1
29	Lining for C.400-S, mild steel	5000030650 30650	1
29	Lining for C.400-S stainless steel	5000032452 32452	1
29	Lining for C.400-S2T, stainless steel	5000030647 30647	1
29	Lining for C.400-2T70, stainless steel (type A)	5000030645 30645	1
29	Lining for C.400-2T70, stainless steel (type B)	5000030646 30646	1
30	Hole plate		1
37	Motor	5000010114 10114	1
38	Belt pulley for motor, Poly-V 24M180	5000023835 23835	1
39	Belt pulley for gear, Poly-V 24M630	5000023842 23842	1
40	Belt Poly-V, 990 M24	5000024046 24046	1
41	Machine shoe	5000027874 27874	4
44	Retaining ring, 400/70	5000031114 31114	1
45	Travelling trolley for gear	5000030216 30216	2



Follow us on LinkedIn

Follow us on Facebook

## Wolfking® / CFS® / GEA® Grinder Parts - Parts List for Wolfking® C.400 (Cont.)

### Parts List for Wolfking® Grinder C.400-UNI (Part 3 of 3)

Pos. No.	Description	Part Number	Qty.
46	Travelling trolley for tackle	5000030751 30751	2
47	Lifting gallows	5000047960 47960	1
52	Suspension at gear	5000080449 80449	1
53	Set screw, M12x25	5000022034 22034	4
54	Washer, M12	5000022725 22725	4
55	Nut, M12, stainless steel	5000022307 22307	4
59	Washer, Ø50xØ30.5x3 mm, brass	5000023063 23063	4
61	Retaining bolt, M30x500	5000048889 48889	2
72	Set screw, M6x12, stainless steel	5000022185 22185	7
73	Bottom plate for cabinet	5000047153 47153	1
74	Toothed wheel tackle	5000025610 25610	2
74	Chain hurl with chain	5000025612 25612	1
76	Key, 25x14x51	5000030724 30724	4
77	Screw for key	5000022358 22358	4
	Etronax ring for crane arm	50000300054 300054	1
78	Safety guard	5000030084 300984	1
79	Allen, MK, M10x35	5000022590 22590	1

## Wolfking® / CFS® / GEA® Grinder Parts - Supporting Ring for Screw Cap

Machine Type	Description	Part Number
Wolfking® C.400-UNI	Supporting ring for screw cap	50000030765 30765



Supporting ring for screw cap, part number 5000030765 /30765

## Wolfking® / CFS® / GEA® Grinder Parts - Cabinet Dimensions

### Dimensions for Wolfking® Grinder B.400-UNI-HD

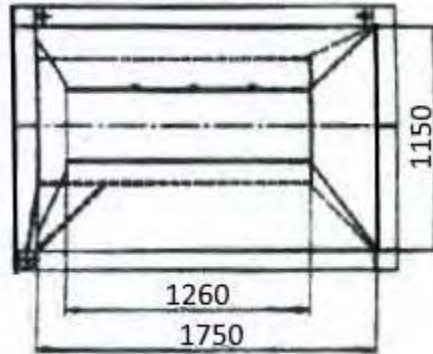

### Dimensions for Wolfking® Grinder C.400-UNI

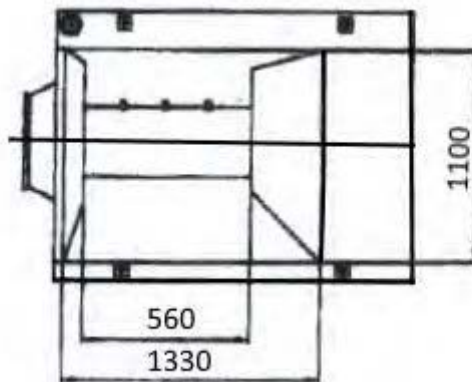

### Dimensions for Wolfking® Grinder C.400-UNI-HD

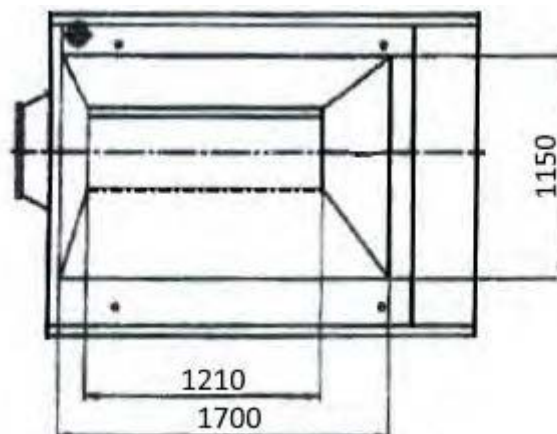

HD = Heavy Duty

## Wolfking® / CFS® / GEA® / Simo® Grinder Parts

Machine Type	Description	Part Number
Simo® 400	Worm M400/290F 25 OD M92, mild steel	sigr200-400x3502-9000205
Simo® 400	Lining, 400/190, mild steel	sigr220-400/190x3501-05









Worm M400/290F 25 OD M92, mild steel,  
part number sigr200-400x3502-9000205





Lining, 400/190, mild steel  
part number sigr220-400/190x3501-05

## Wolfking® / CFS® / GEA® Grinder Parts - AutoGrind 200

Machine Type	Description	Part Number
CFS® AutoGrind 200 GEA® AutoGrind 200	Pilot bearing	5000452319  452319  3092232 
CFS® AutoGrind 200 GEA® AutoGrind 200	Bushing for pilot bearing	452317
CFS® AutoGrind 200 GEA® AutoGrind 200	Lining	3610705 
CFS® AutoGrind 200 GEA® AutoGrind 200	Feeding worm	3610522G02  3610784K  3610833M
CFS® AutoGrind 200 GEA® AutoGrind 200	Worm pin for feeding worm 3610522G02	36100S2501



Pilot bearing for AutoGrind 200,  
part number 452319  / 3092232 

## Wolfking® / CFS® / GEA® Grinder Parts - AutoGrind 280



Bearing housing,  
part number 38911 



Bearing housing,  
part number 389117 



Lining,  
part number 3550841



### Wolfking® / CFS® / GEA® Grinder Parts - AutoGrind 280 (Cont.)

Machine Type	Description	Part Number
CFS® AutoGrind 280 GEA® AutoGrind 280	Bearing housing	389117
CFS® AutoGrind 280 GEA® AutoGrind 280	Bushing for pilot bearing	452403
CFS® AutoGrind 280 GEA® AutoGrind 280	Pilot bearing	38746
CFS® AutoGrind 280 GEA® AutoGrind 280	Ring	389113
CFS® AutoGrind 280 GEA® AutoGrind 280	Ring	389115
CFS® AutoGrind 280 GEA® AutoGrind 280	Housing	389168
CFS® AutoGrind 280 GEA® AutoGrind 280	Spring for FlexGrind system	430098
CFS® AutoGrind 280 GEA® AutoGrind 280	Spring for FlexGrind system	430099
CFS® AutoGrind 280 GEA® AutoGrind 280	Wear ring for drive shaft	361624
CFS® AutoGrind 280 GEA® AutoGrind 280	Drive shaft	3550877K
CFS® AutoGrind 280 GEA® AutoGrind 280	Bearing cap	3550527
CFS® AutoGrind 280 GEA® AutoGrind 280	Pilot bearing, 3 spokes	452402
CFS® AutoGrind 280 GEA® AutoGrind 280	Lining	3550841
CFS® AutoGrind 280 GEA® AutoGrind 280	Feeding worm	35540001 3550847K 3550848M-S 3550847K-S 3550848M
CFS® AutoGrind 280 GEA® AutoGrind 280	Pilot bearing, 4 spokes	452404
CFS® AutoGrind 280 GEA® AutoGrind 280	Bushing for pilot bearing	452405

## Wolfking® / CFS® / GEA® Grinder Parts - AutoGrind 280 (Cont.)



Ring,  
part number 389113 



Ring,  
part number 389115 



Bushing,  
part number 452317-1 



Pilot bearing, 4 spokes  
part number 452404 

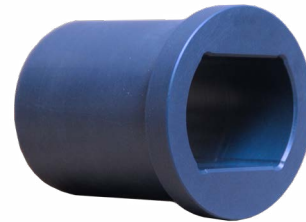

D-nut for pilot bearing  
part number 452403 

## Wolfking® / CFS® / GEA® Grinder Parts - AutoGrind 280 (Cont.)



Main bearing shaft for AutoGrind 280,  
part number 5000317557 / 317557

Machine Type	Description	Part Number
CFS® AutoGrind 280	Main bearing shaft	5000317557
GEA® AutoGrind 280		317557
		5000397696
		397696



Shown from worm/auger side -  
main bearing shaft for AutoGrind 280,  
part number 5000317557 / 317557

## Wolfking® / CFS® / GEA® Emulsifier Parts - EcoCut E.225



QuadroCut knife housing shown with key for EcoCut E.225  
part number



Inlet cone for EcoCut E.225,  
part number 50000369888 ✓/369888 ✓

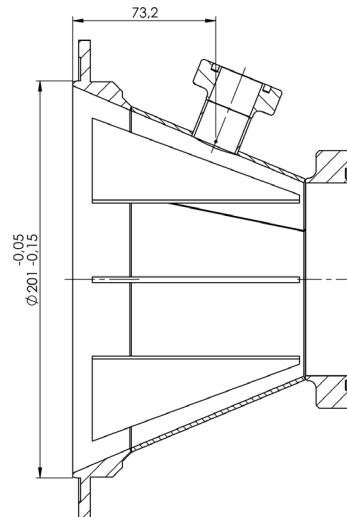
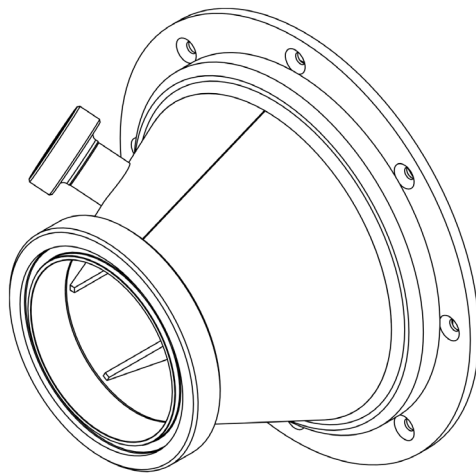

Inlet cone with fitting for pressure for EcoCut E.225.  
part number 43-301

## Wolfking® / CFS® / GEA® Emulsifier Parts - EcoCut E.225 (Cont.)

### Inlet Cone Assembly For EcoCut E.225, Part Number 5000321784

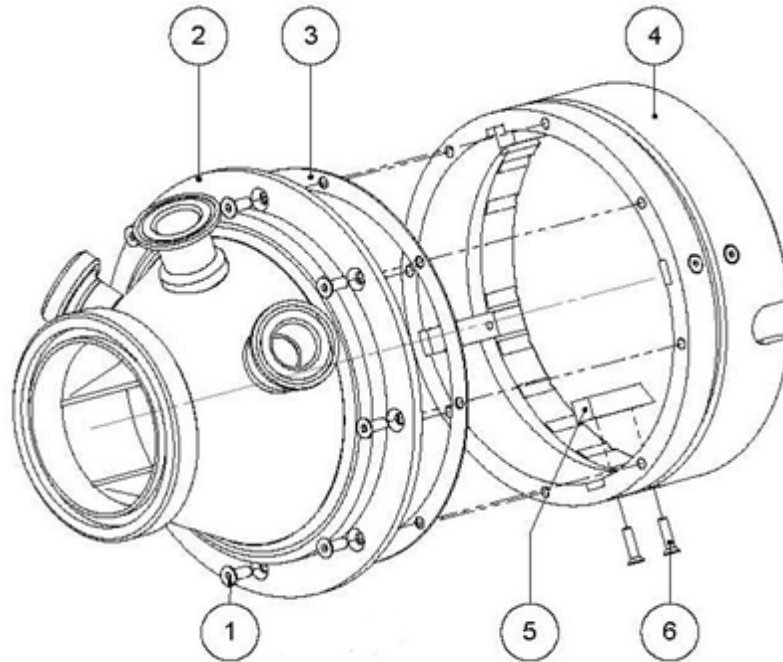

Pos. No	Description	Wolfking® / CFS® EcoCut 225	GEA® EcoCut 225
1	Allen screw flat M6x16 SS	22569	500022569
2	Inlet cone conical	317563	5000317563
3	Gasket for wear ring	304586	5000304586
4	Wear ring	312793	5000312793
5	Ribbon for wear ring	304579	5000304579
6	Allen screw flat M5x20 SS	3276	500003276

## Wolfking® / CFS® / GEA® Emulsifier Parts - EcoCut E.225 (Cont.)

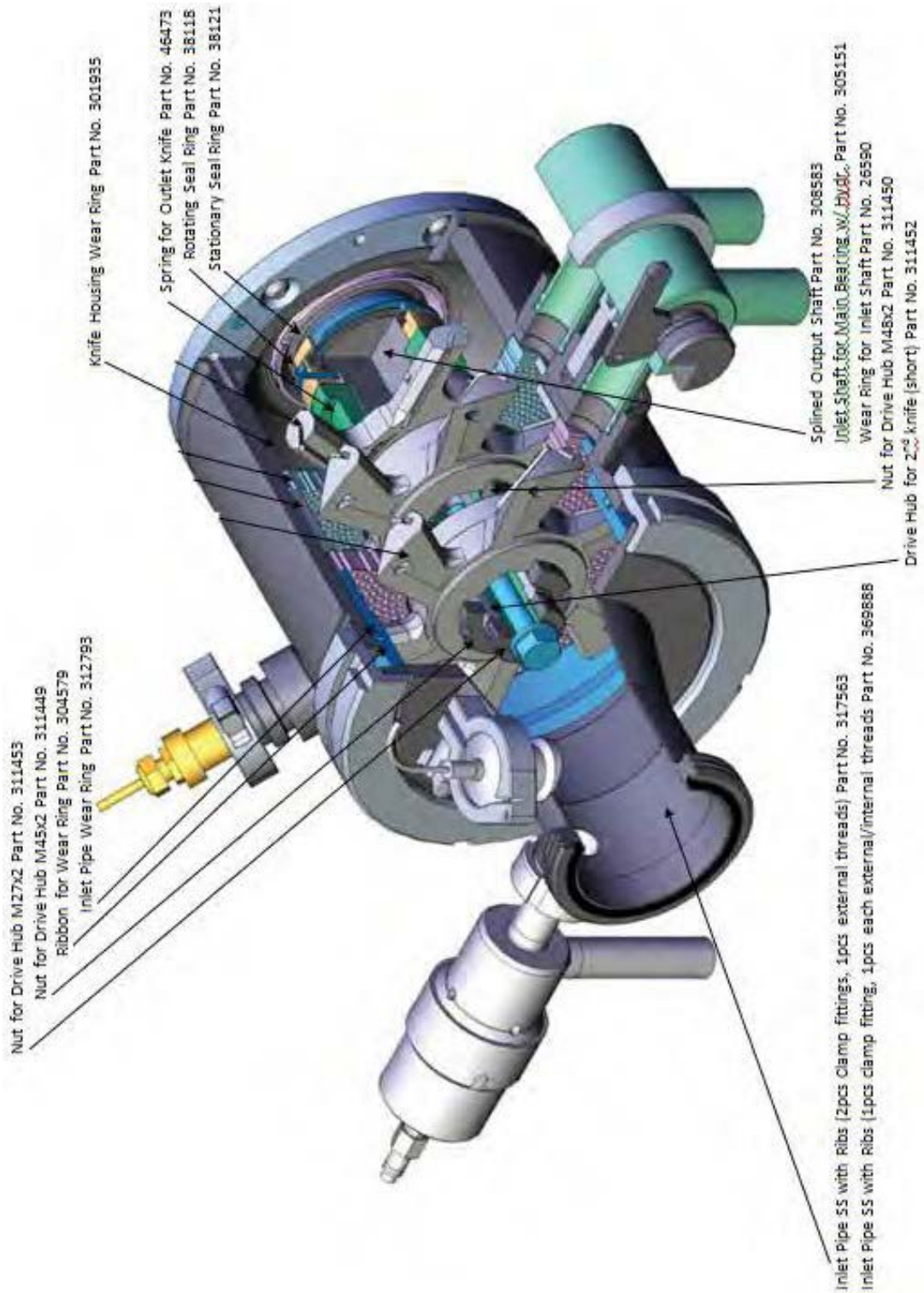































[www.koncepttech.com](http://www.koncepttech.com)

Koncept Tech ApS, Industrivej 6, DK-4200 Slagelse, Denmark, Phone: +45 70271410 E-mail: [parts@koncepttech.com](mailto:parts@koncepttech.com)

All items, parts, and accessories listed on the website of Koncept Tech ApS, are manufactured by Koncept Tech ApS, or manufactured by Koncept Tech ApS, specifications. The names of the original equipment manufacturers referred to on this site, such as but not limited to: Camille®; Handlmann®, K&G®, Krämer + Grebe®, CFS®, GEA®, Karl Schmid®, KS®, Laska®, Palma®, Pelmo®, Seydelmann®, Simo®, Harslev®, Weiler®, Weller®, Mincomaster®, ANCO®, Cuzzini®, The Middleby Corporation®, Wolfking®, Comvair®, Auto®, Beehive®, Yieldmaster®, Meatmaker®, Poss®, Townsend®, Lima® etc. are all registered trademarks of their respective companies. All original equipment manufacturer's names are listed as Camillech® type, Handlmann® type, K&G® type, Krämer + Grebe® type, CFS® type, Karl Schmid® type, KS® type, Laska® type, Palma® type, Pelmo® type, Seydelmann® type, Simo® type, Harslev® type, Weiler® type, Mincomaster® type, ANCO® type, Cuzzini® type, Wolfking® type, Comvair® type, Auto® type, Beehive® type, Yieldmaster® type, Meatmaker® type, Poss® type, Townsend® type, Lima® type to indicate that these items are manufactured by Koncept Tech ApS, and not the original equipment manufacturers. Unless specifically stated otherwise, Koncept Tech ApS, has no association or affiliation with any entities/companies listed.

### Wolfking® / CFS® / GEA® Emulsifier Parts - EcoCut E.225 (Cont.)

Machine Type	Description	Part Number
Wolfking® EcoCut E.225 CFS® EcoCut E.225 GEA® EcoCut E.225	Nut for drive hub M27x2	5000311453  311453 
Wolfking® EcoCut E.225 CFS® EcoCut E.225 GEA® EcoCut E.225	Nut for drive hub M45x2	5000311449  311449 
Wolfking® EcoCut E.225 CFS® EcoCut E.225 GEA® EcoCut E.225	Ribbon for wear ring	5000304579  304579 
Wolfking® EcoCut E.225 CFS® EcoCut E.225 GEA® EcoCut E.225	Inlet cone wear ring	5000312793  312793 
Wolfking® EcoCut E.225 CFS® EcoCut E.225 GEA® EcoCut E.225	Knife housing wear ring	5000301935  301935 
Wolfking® EcoCut E.225 CFS® EcoCut E.225 GEA® EcoCut E.225	Spring for outlet knife	5000046473  46473 
Wolfking® EcoCut E.225 CFS® EcoCut E.225 GEA® EcoCut E.225	Seal ring, rotating	5000038118  38118 
Wolfking® EcoCut E.225 CFS® EcoCut E.225 GEA® EcoCut E.225	Seal ring, stationary	5000038121  38121 
Wolfking® EcoCut E.225 CFS® EcoCut E.225 GEA® EcoCut E.225	Inlet cone with ribs (2 pcs. clamp fitting, 1 pcs. external threads), stainless steel	5000317563 317563
Wolfking® EcoCut E.225 CFS® EcoCut E.225 GEA® EcoCut E.225	Inlet cone with ribs (1 pcs. clamp fitting, 1 pcs. external/internal threads), stainless steel	5000369888  369888 
Wolfking® EcoCut E.225 CFS® EcoCut E.225 GEA® EcoCut E.225	Inlet cone with ribs (1 pcs. clamp fitting, 1 pcs. external/internal threads), stainless	43-301
Wolfking® EcoCut E.225 CFS® EcoCut E.225 GEA® EcoCut E.225	Splined output shaft	5000308583  308583 
Wolfking® EcoCut E.225 CFS® EcoCut E.225 GEA® EcoCut E.225	Inlet shaft for main bearing	5000305151  305151 
Wolfking® EcoCut E.225 CFS® EcoCut E.225 GEA® EcoCut E.225	Wear ring for inlet shaft	5000026590  26590 
Wolfking® EcoCut E.225 CFS® EcoCut E.225 GEA® EcoCut E.225	Nut for drive hub	5000311450  311450 
Wolfking® EcoCut E.225 CFS® EcoCut E.225 GEA® EcoCut E.225	Drive hub for second knife	5000311452  311452 
Wolfking® EcoCut E.225 CFS® EcoCut E.225 GEA® EcoCut E.225	Hub for knife set	5000311451  311451 
Wolfking® EcoCut E.225 CFS® EcoCut E.225 GEA® EcoCut E.225	Knife Housing Wear Ring	301935 

## Wolfking® / CFS® / GEA® Emulsifier Parts - EcoCut E.225 (Cont.)

### Knife Cassette Assembly

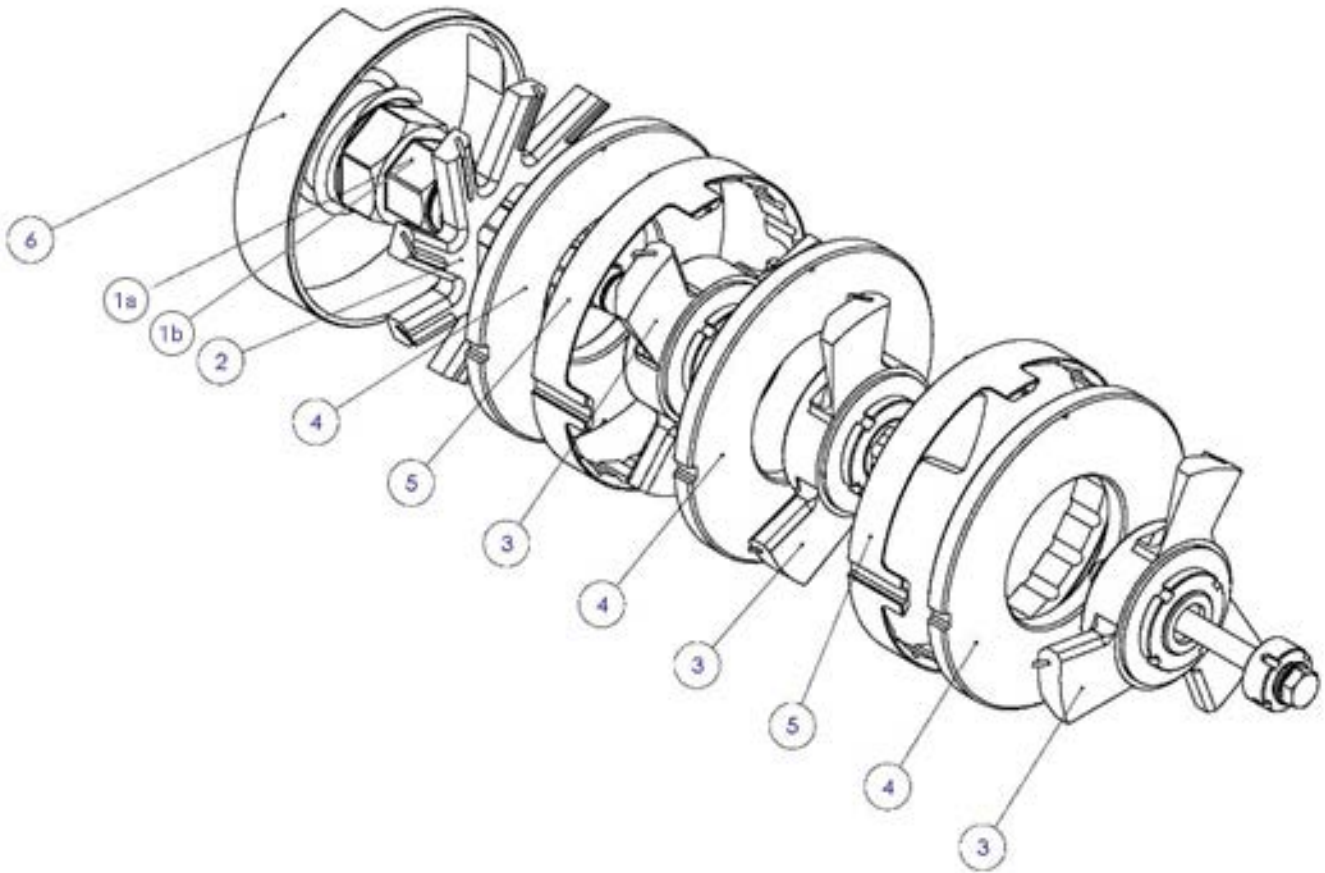

\*EcoCut and Triplecut 2pcs hole plates, Qaudrocut 3pcs hole plate assembly

Pos. No	Description	Wolfking®/ CFS® EcoCut 225	GEA® EcoCut 225
1a	Drive hub	311451	5000311451
1b	Drive hub	43-107	43-107
2	Knife outlet	3, 6, 9 or 12 arms	3, 6, 9 or 12 arms
3	Knife inlet	3 or 6 arms	3 or 6 arms
4	Holeplate	1.2-10mm	1.2-10mm
5	Holeplate spacer	312693	5000312693
6	Knife-housing wear ring	301935	5000301935



## Wolfking® / CFS® / GEA® Emulsifier Parts - EcoCut E.225 (Cont.)

### Knife Cassette Drive Hub Assembly

Pos. No	Description	Wolfking® / CFS® EcoCut 225	GEA® EcoCut 225
1	Drive hub	311451	5000311451
2	Drive hub 2nd	311452	5000311452
4	Drive hub nut M48x2 LH	311450	5000311450
5	Drive hub nut M27x2	311453	5000311453
6	Drive hub nut M45x2	311449	5000311449
7	Drive hub spring	46473	5000046473
8	Washer	22726	5000022726
9	Bolt	22927	5000022150



## Wolfking® / CFS® / GEA® Emulsifier Parts - EcoCut E.225 (Cont.)

### Hydraulic Piston Assembly

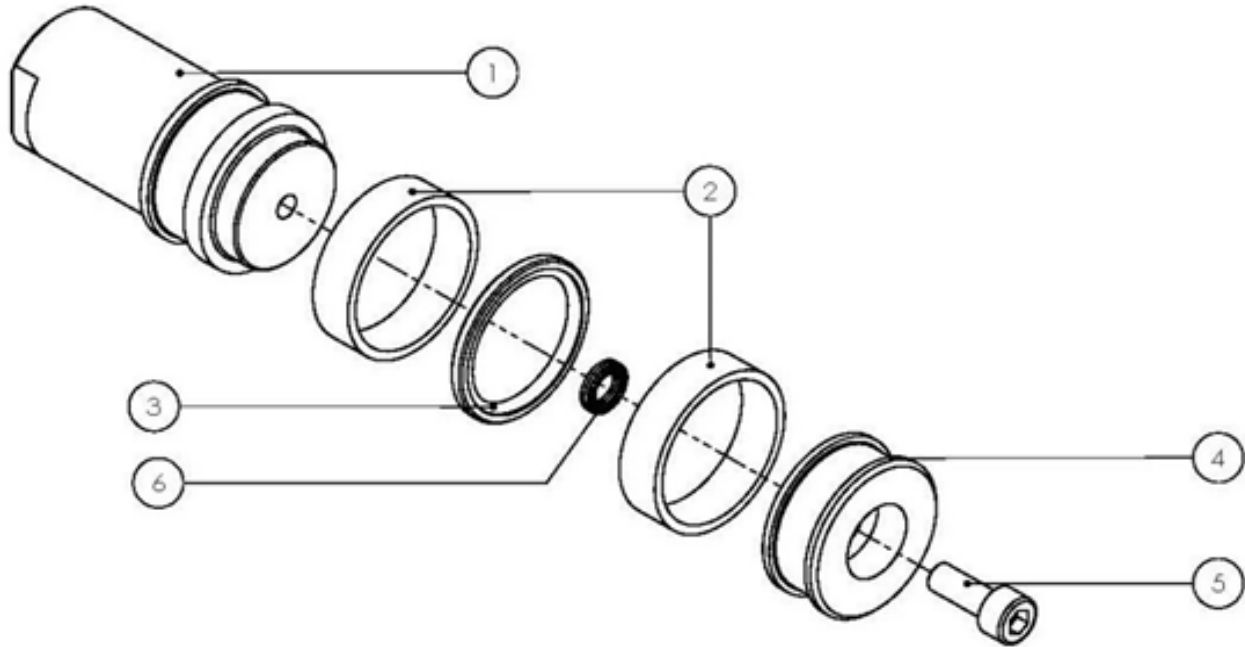

Pos. No	Description	Wolfking® / CFS® EcoCut 225	GEA® EcoCut 225
1	Piston	308553	5000308553
2	Sleeve bushing	29838	5000029838
3	Seal	29717	5000029717
4	End piece for piston	308554	5000308554
5	Allen head screw M6x15 SS	22606	5000022606
6	Lock washer M6 SS	3421	5000003421

## Wolfking® / CFS® / GEA® Emulsifier Parts - EcoCut E.225 (Cont.)

### Exploded View of Adjusting Device for EcoCut E.225, Part Number 308969

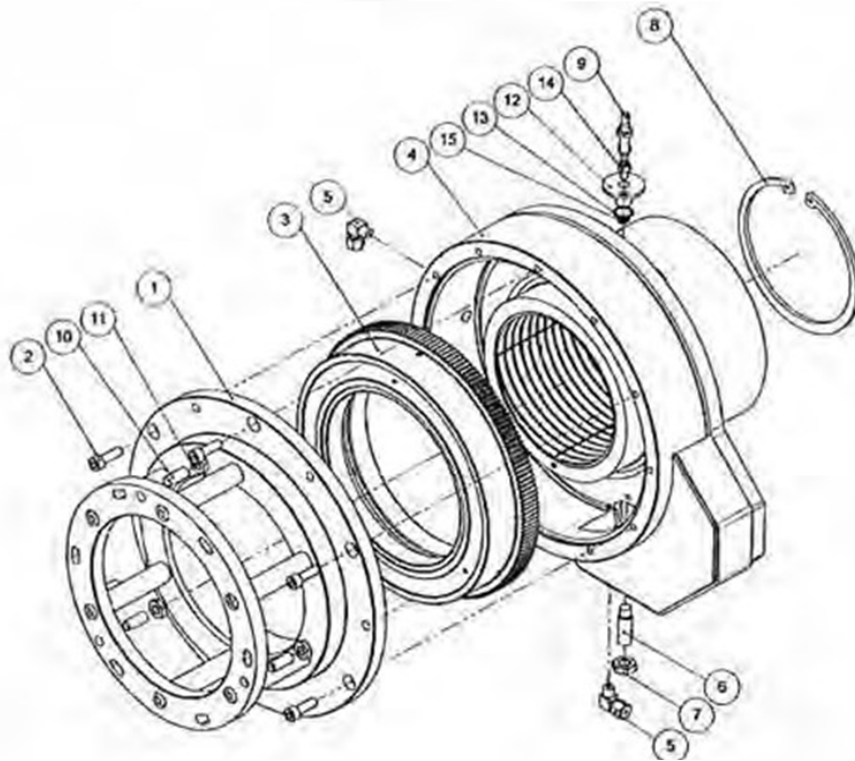

Adjustment device for Emulsifier 225  
part number 308969

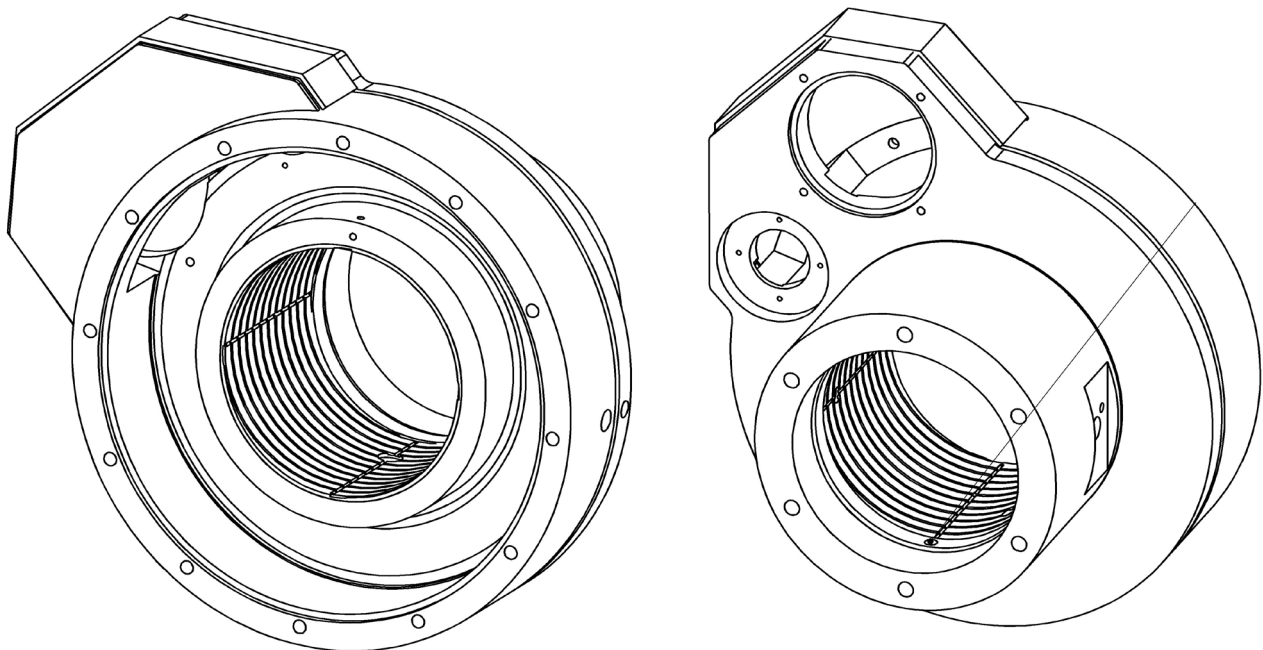

Housing for knife adjustment for Emulsifier 225  
part number 308967

[www.koncepttech.com](http://www.koncepttech.com)

Koncept Tech ApS, Industrivej 6, DK-4200 Slagelse, Denmark, Phone: +45 70271410 E-mail: [parts@koncepttech.com](mailto:parts@koncepttech.com)

All items, parts, and accessories listed on the website of Koncept Tech ApS, are manufactured by Koncept Tech ApS, or manufactured to Koncept Tech ApS, specifications. The names of the original equipment manufacturers referred to on this site, such as but not limited to: Camilech®, Handtmann®, K&G®, Krämer + Grebe®, CFS®, GEA®, Karl Schnell®, KS®, Laska®, Palma®, Pelsmo®, Seydelmann®, Simo®, Hørslev®, Weiler®, MincoMaster®, ANCO®, Cozzini®, The Middleby Corporation®, Wolfking®, Comvair®, Auto®, Beehive®, Yieldmaster®, Meatmaker®, Poss®, Townsend®, Lima®, etc. are all registered trademarks of their respective companies. All original equipment manufacturer's names are listed as Camilech® type, Handtmann® type, K&G® type, Krämer + Grebe® type, CFS® type, Karl Schnell® type, KS® type, Laska® type, Palma® type, Pelsmo® type, Simo® type, Hørslev® type, Weiler® type, MincoMaster® type, ANCO® type, Cozzini® type, Wolfking® type, Comvair® type, Auto® type, Beehive® type, Yieldmaster® type, Meatmaker® type®, Poss® type, Townsend® type, Lima® type to indicate that these items are manufactured by Koncept Tech ApS, and not the original equipment manufacturers. Unless specifically stated otherwise, Koncept Tech ApS, has no association or affiliation with any entities/companies listed.

### Wolfking® / CFS® / GEA® Emulsifier Parts - EcoCut E.225 (Cont.)

#### Parts List for Adjusting Device for EcoCut E.225 Part Number 308969

Machine Type	Pos. No.	Description	Qty.	Part Number
Wolfking® EcoCut E.225 CFS® EcoCut E.225 GEA® EcoCut E.225	01	Flush cover	1	5000307431 307431
Wolfking® EcoCut E.225 CFS® EcoCut E.225 GEA® EcoCut E.225	02	Front bearing cover	1	5000308964 308964
Wolfking® EcoCut E.225 CFS® EcoCut E.225 GEA® EcoCut E.225	03	Front bearing housing	1	5000308965 308965
Wolfking® EcoCut E.225 CFS® EcoCut E.225 GEA® EcoCut E.225	04	Output shaft	1	5000308583 308583
Wolfking® EcoCut E.225 CFS® EcoCut E.225 GEA® EcoCut E.225	05	Bonded seal, M6 mm, size ref. 867, stainless steel	6	5000140062 140062
Wolfking® EcoCut E.225 CFS® EcoCut E.225 GEA® EcoCut E.225	08	Lock nut, M70x20, type FU 14, stainless steel	1	5000026134 26134
Wolfking® EcoCut E.225 CFS® EcoCut E.225 GEA® EcoCut E.225	09	Angle contact ball bearing, C3	1	5000027615 27615
Wolfking® EcoCut E.225 CFS® EcoCut E.225 GEA® EcoCut E.225	10	Labyrinth seal, Z015	2	5000026116 26116
Wolfking® EcoCut E.225 CFS® EcoCut E.225 GEA® EcoCut E.225	11	Stuffing box	1	5000307432 307432
Wolfking® EcoCut E.225 CFS® EcoCut E.225 GEA® EcoCut E.225	12	Slip ring, Ø18xØ5.33	1	5000140061 140061
Wolfking® EcoCut E.225 CFS® EcoCut E.225 GEA® EcoCut E.225	13	Hexagon head screw, M6x30-A2	6	5000022189 22189
Wolfking® EcoCut E.225 CFS® EcoCut E.225 GEA® EcoCut E.225	15	V-ring, Viton, VA 70, 68x73 mm	1	5000027724 27724
Wolfking® EcoCut E.225 CFS® EcoCut E.225 GEA® EcoCut E.225		Lubrication nipple, M6, DV1-M6x1, straight	2	5000025348 25348
Wolfking® EcoCut E.225 CFS® EcoCut E.225 GEA® EcoCut E.225		O-ring, synthetic, 70.00x3.00 mm	1	5000028888 28888
Wolfking® EcoCut E.225 CFS® EcoCut E.225 GEA® EcoCut E.225		Thread connection, 1/8"xØ6, straight, type 223-13614-9	1	5000029728 29728

## Wolfking® / CFS® / GEA® Emulsifier Parts - EcoCut E.225 - Electrical Parts

Machine Type	Description	Part Number
Wolfking® EcoCut E.225 CFS® EcoCut E.225 GEA® EcoCut E.225	Temperature sensor pipe	5000014499 14499
Wolfking® EcoCut E.225 CFS® EcoCut E.225 GEA® EcoCut E.225	Pressure transmitter	5000046607 <input checked="" type="checkbox"/> 46607 <input checked="" type="checkbox"/>
Wolfking® EcoCut E.225 CFS® EcoCut E.225 GEA® EcoCutE.225	Safety lock switch 10 m wire	50000014321 <input checked="" type="checkbox"/> 14321 <input checked="" type="checkbox"/> 5000377110 377110 4828-1
Wolfking® EcoCut E.225 CFS® EcoCut E.225 GEA® EcoCut E.225	Ferrogard magnetic switch 10m wire	5000367768 367768
Wolfking® EcoCut E.225 CFS® EcoCut E.225 GEA® EcoCut E.225	Safety wire kit 20 m (Tripwire, wire 20 m, spring)	otmm900-xSafetywirekit <input checked="" type="checkbox"/>
Wolfking® EcoCut E.225 CFS® EcoCut E.225 GEA® EcoCut E.225	PT 100 sensor with flange	wkgr900-PT100xKP5452656-4 <input checked="" type="checkbox"/>



PT 100 sensor with clamp,  
part numberwkgr900-PT100xKP5452656-4

## Wolfking® / CFS® / GEA® Emulsifier Parts - EcoCut E.225 (Cont.)

### Input Shaft Assembly For EcoCut E.225, Part Number 505152

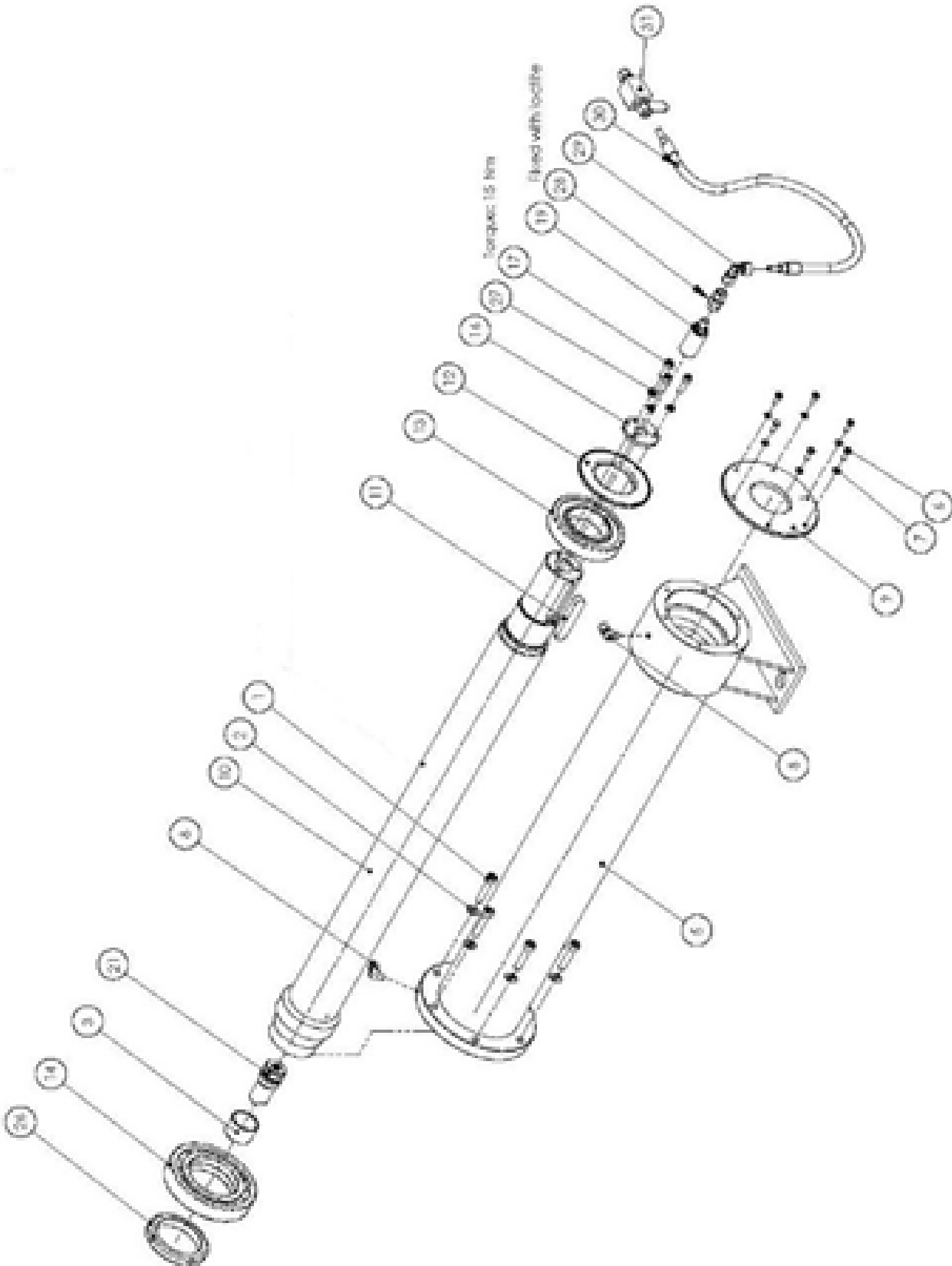

\*To see part list for Input Shaft Assembly, please see page no. 70



Follow us on LinkedIn

Follow us on Facebook

## Wolfking® / CFS® / GEA® Emulsifier Parts - EcoCut E.225 (Cont.)

### Input Shaft Assembly, Part Number 505152

Pos. No	Description	Wolfking® / CFS® EcoCut 225	GEA® EcoCut 225
1	Allen screw M10x45 SS	22638	5000022638
2	Washer M10 SS	22724	5000022724
3	Wear ring	26590	5000026590
5	Housing for input shaft	305153	5000305153
6	Hex head screw M6x16 SS	22186	5000022186
7	Washer M6 SS	22722	5000022722
8	Lubrication nipple 1/8" 90°	29521	5000029521
9	Housing end cover	47438	5000047438
10	Input shaft	305151	5000305151
11	Parallel key 18x11x90	24763	5000024763
12	Labyrinth seal Z214	26111	5000026111
13	Cylindrical roller bearing	27859	5000027859
14	Ball bearing	23405	5000023405
16	Input shaft end cover	304929	5000304929
17	Allen screw M8x25 SS	22620	5000022620
19	Rotating union 70bar	23159	5000023159
21	Piston for hydraulic	308555	5000308855
26	Lock Nut M80x2 FU16	23429	5000023429
27	Lock washer Nord-Lock M8	3421	5000003422
28	Hydraulic connection straight	29742	5000029742
29	Hydraulic connection angle	29510	1000216523
30	Hydraulic hose 500mm	29946	5000029946
31	Ball valve	29518	5000029518

## Wolfking® / CFS® / GEA® Emulsifier Parts - EcoCut E.225 (Cont.)

### Output Shaft Assembly

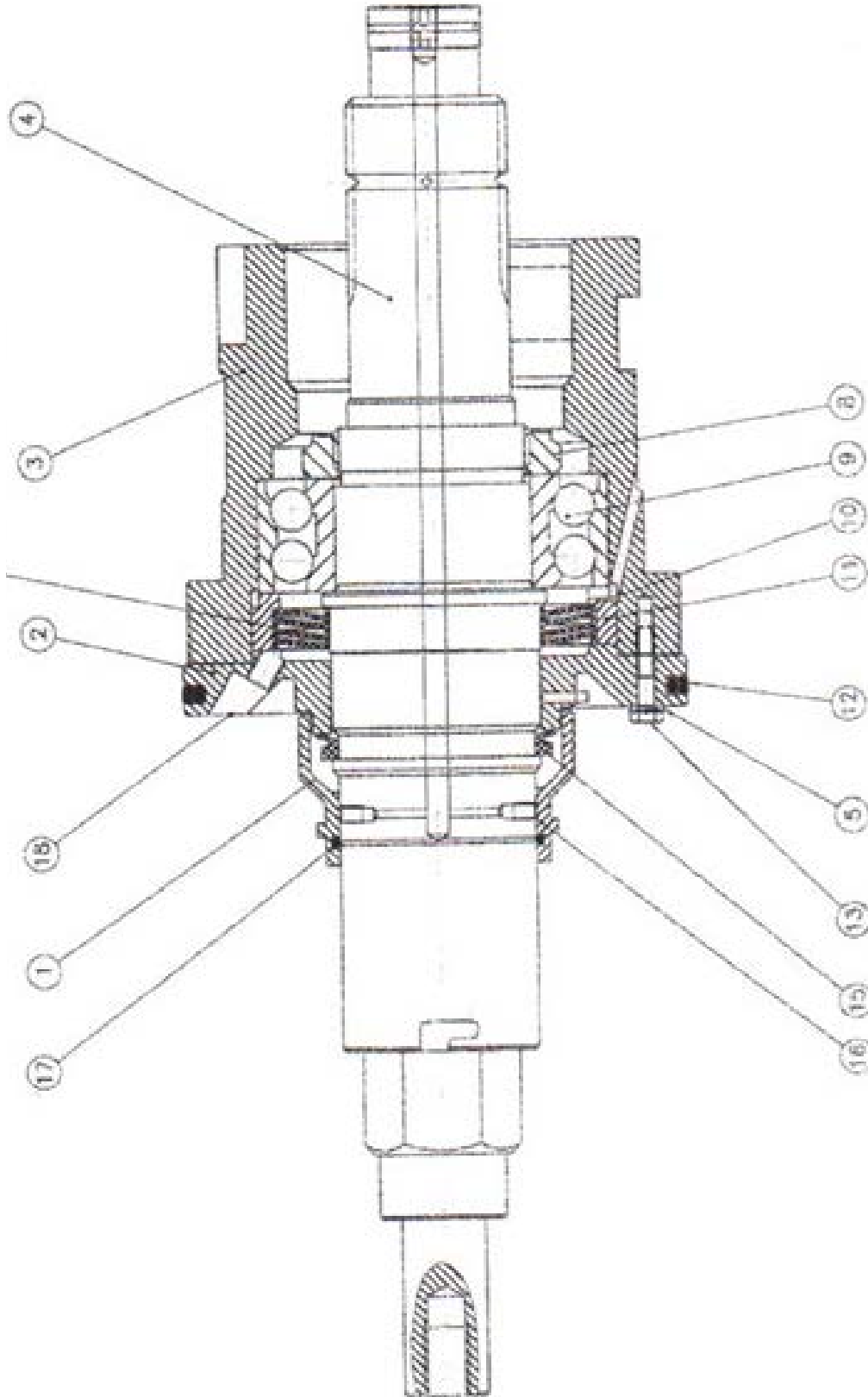

\*To see part list for Output Shaft Assembly, please see page no. 72



### Wolfking® / CFS® / GEA® Emulsifier Parts - EcoCut E.225 (Cont.)

#### Output Shaft Assembly

Pos. No	Description	Wolfking® / CFS® EcoCut 225	GEA® EcoCut 225
1	Flush cover	307431	5000307421
2	Front bearing cover	308964	5000308964
3	Front bearing housing	308965	1000295413
4	Output shaft	308583	5000308583
5	Norlock M6 18/8	140062	5000140062
8	Locknut M70x2 18/8	26134	5000026134
9	Angle contact bearing	27615	5000029316/5000029506
10	Labyrinth seal Z015	26116	5000026116
11	Stuffing box	307432	1000295482
12	Slip ring 180x5.33	140061	5000140061
13	Hex head screw M6x30	22189	5000022189
15	V-ring Viton VA70	27724	5000027724
16	Lube nipple DV1-M6x1	25348	1000295457*
17	O-ring 70x3	28888	1000300682
18	Lubrication nipple	29728	5000029728

\* For GEA Emulsifier Pos 16 is a spacer ring, that is located between the 2pcs bearings at Pos 9

## Wolfking® / CFS® / GEA® Emulsifier Parts - EcoCut E.225 (Cont.)

### Knife Adjustment Motor Assembly

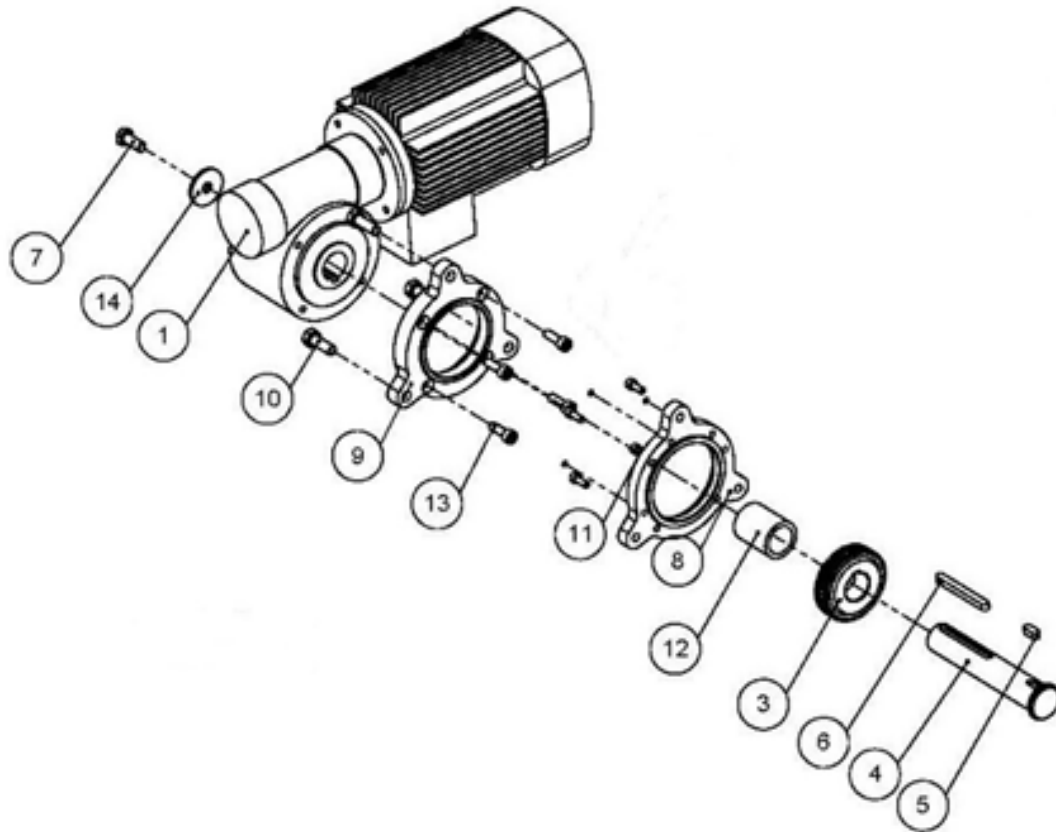

Pos. No	Description	Wolfking® / CFS® EcoCut 225	GEA® EcoCut 225
1	BJ gear motor	29074	5000029074
3	Gear wheel	311551	5000311551
4	Shaft for gear motor	311549	5000311549
5	Parallel key	24828	5000024828
6	Parallel key	24722	5000024722
7	Hexagon screw M10x25 SS	22209	5000022209
8	Base for gear motor	311546	5000311546
9	Flange for gear motor	311547	5000311547
10	Hexagon screw M10x30 SS	22210	5000022210
11	Allen screw flat M6x16 SS	22569	5000022606
12	Bushing for shaft	311548	5000311548
13	Allen screw M8x25	22580	5000022620
14	Washer for gear motor 40x11x5	34597	5000034597

## Wolfking® / CFS® / GEA® Emulsifier Parts - EcoCut E.225 (Cont.)

### Bone Elimination System Assembly

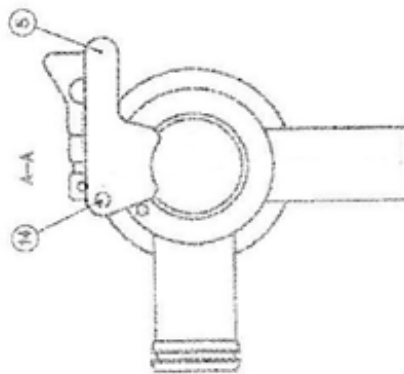
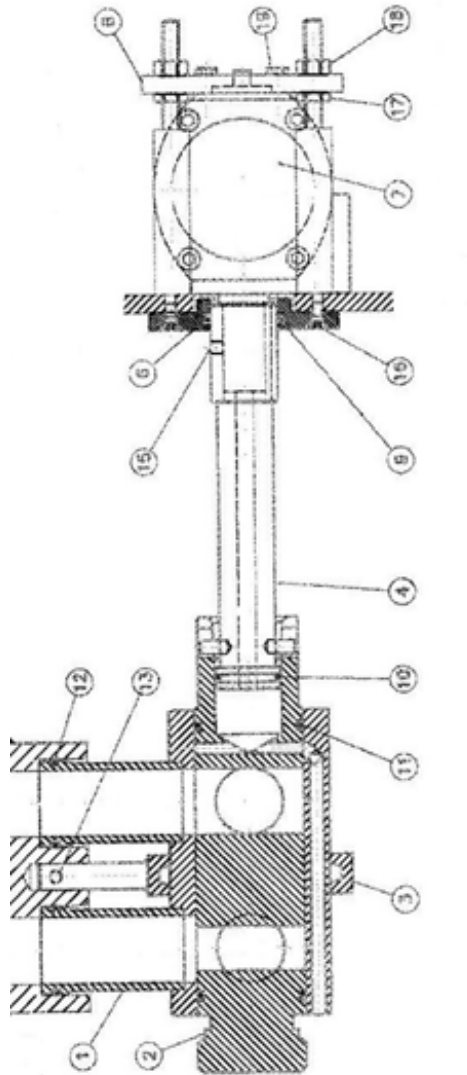

\*To see part list for Bone Elimination System Assembly  
 please see page no. 75

## Wolfking® / CFS® / GEA® Emulsifier Parts - EcoCut E.225 (Cont.)

### Bone Elimination System Assembly, Part Number 312445

Pos. No	Description	Wolfking® / CFS® EcoCut 225	GEA® EcoCut 225
1	Cylinder for double BES	312446	5000312446
2	Rotating piston for BES	318226	5000312447
3	Clamp for double BES	309076	5000309076
4	Drive shaft for double BES	309079	5000309079
5	Lock for rotating piston	309074	5000381930
6	Cover plate	304133	5000304133
7	Actuator cylinder	38789	5000038789
8	Mounting plate	304135	5000304135
9	O-ring 30.0x3.0	23229	1000300364
10	O-ring 24.2x3.0	23396	1000300670
11	O-ring 40.86x3.53	23247	1000300515
12	O-ring 34.5x3.0	23237	1000300368
13	Allen set screw M8x16 SS	22861	K002170
14	Hex head screw M6x16 SS	22186	5000022570
15	Allen set screw M6x6 SS	22670	5000022670
16	Allen flat head screw M5x12 SS	3275	5000003275
17	Counter nut M8 SS	27426	5000027426
18	Hex nut M8	22305	5000022305
19	Hex head screw M5x16 SS	22179	5000022179

## Wolfking® / CFS® / GEA® Emulsifier Parts - EcoCut E.225 (Cont.)

### Encoder Assembly

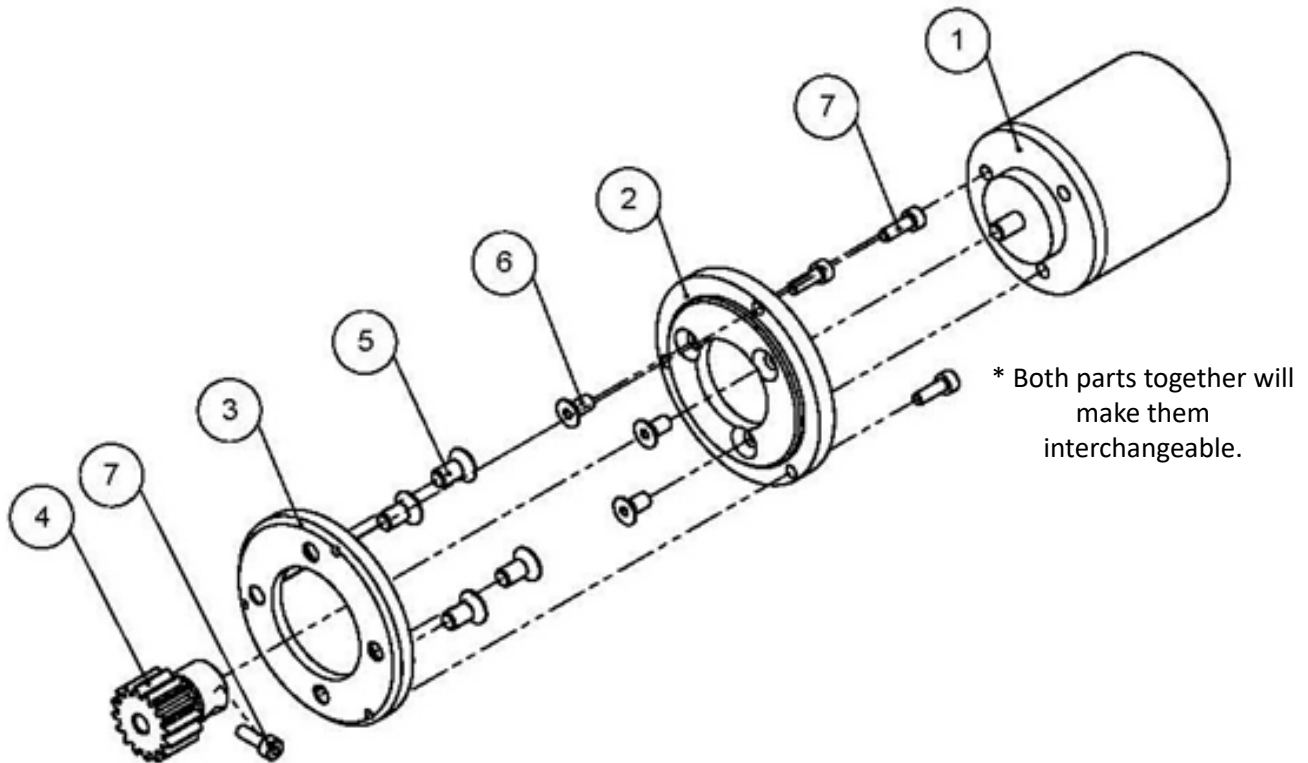

Pos. No	Description	Wolfking® / CFS® EcoCut 225	GEA® EcoCut 225
1	Encoder	16172	5000016172
2	Mounting ring for encoder	308092	5000308092
3	Mounting ring for encoder	307684	5000307684
4	Gear wheel for encoder	308098	5000396166*
5	Allen flat head M6x12 SS	22568	5000022568
6	Allen flat head M5x10 SS	22776	5000022776
7	Allen set screw M3x6 SS	28502	
7	Allen head screw M4x 12 SS		5000026058*

## Wolfking® / CFS® / GEA® Emulsifier Parts - EcoCut E.225 (Cont.)

### Accessory Tools

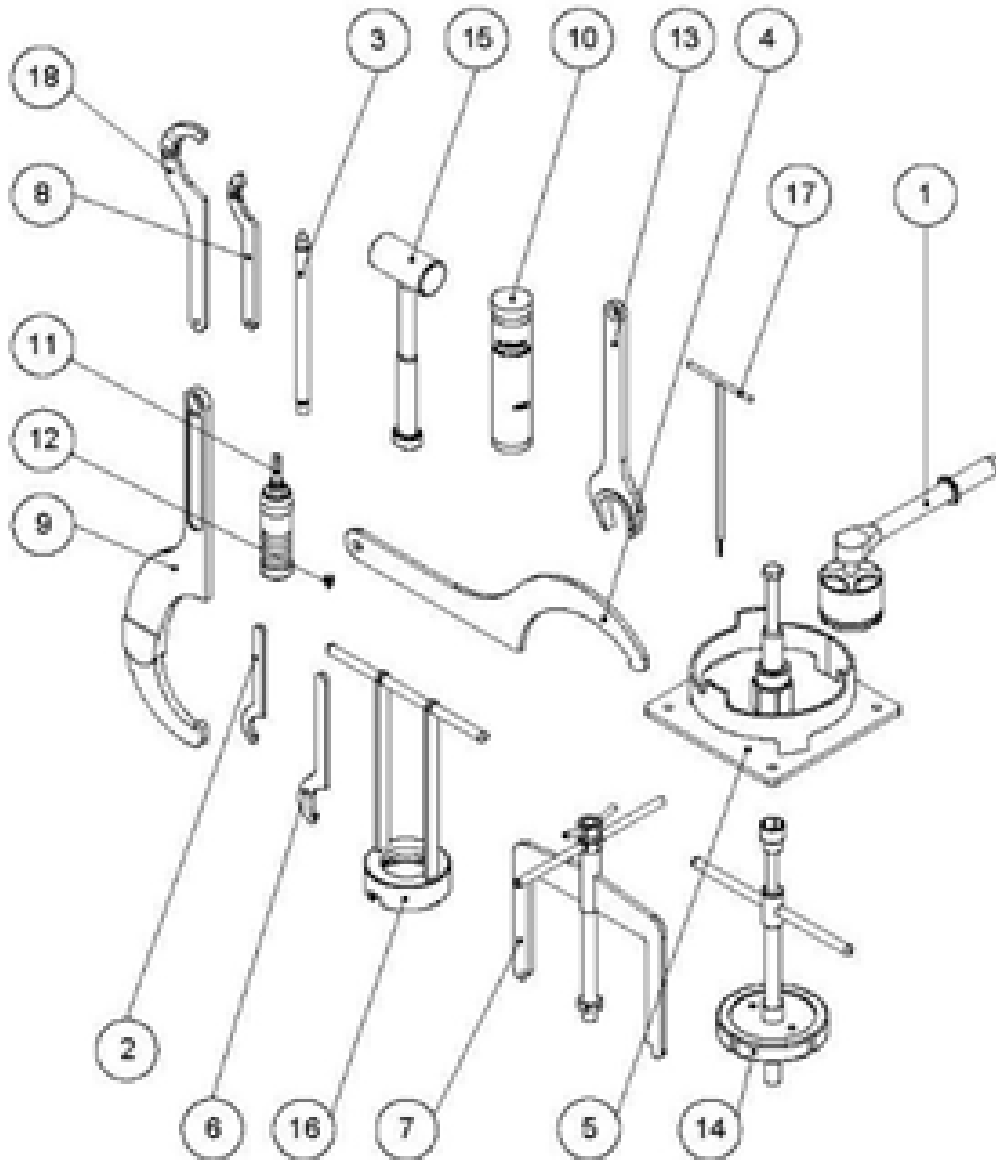

\*To see part list for Accessory Tools  
please see page no. 78

[www.koncepttech.com](http://www.koncepttech.com)

Koncept Tech ApS, Industrivej 6, DK-4200 Slagelse, Denmark, Phone: +45 70271410 E-mail: [parts@koncepttech.com](mailto:parts@koncepttech.com)

All items, parts, and accessories listed on the website of Koncept Tech ApS, are manufactured by Koncept Tech ApS, or manufactured to Koncept Tech ApS specifications. The names of the original equipment manufacturers referred to on this site, such as but not limited to: Camiltech®, Handlmann®, K&G®, Krämer + Grebe®, CFS®, GEA®, Karl Schnell®, KS®, Laska®, Palma®, Pelmo®, Seydelmann®, Simo®, Harslev®, Weiler®, Mincmaster®, ANCO®, Cozzini®, The Middleby Corporation®, Wolfking®, Comvair®, Auto®, Beehive®, Yieldmaster®, Meatmaker®, Poss®, Townsend®, Lima® etc. are all registered trademarks of their respective companies. All original equipment manufacturer's names are listed as Camiltech® type, Handlmann® type, K&G® type, Krämer + Grebe® type, CFS® type, Karl Schnell® type, KS® type, Laska® type, Palma® type, Pelmo® type, Seydelmann® type, Simo® type, Harslev® type, Weiler® type, Mincmaster® type, ANCO® type, Cozzini® type, Wolfking® type, Comvair® type, Auto® type, Beehive® type, Yieldmaster® type, Meatmaker® type, Poss® type, Townsend® type, Lima® type to indicate that these items are manufactured by Koncept Tech ApS, and not the original equipment manufacturers. Unless specifically stated otherwise, Koncept Tech ApS, has no association or affiliation with any entities/companies listed.

### Wolfking® / CFS® / GEA® Emulsifier Parts - EcoCut E.225 (Cont.)

#### Accessory Tools

Pos. No	Description	Wolfking® / CFS® EcoCut 225	GEA® EcoCut 225
1	Torque ratchet	315575	5000386660
2	Hook spanner 45-50mm	311454	1000294115
3	Mounting arbor	310694	5000310694
4	Hook spanner 260mm	39023	5000039023
5	Set-up tool	311456	5000311456
6	Hook spanner 68-75mm	311455	5000311455
7	Knife cassette puller	311557	5000311557
8	Hook spanner		G276545
9	Hook spanner 155-230mm	25688	5000025688
10	Grease		1000233306
11	Grease gun	25700	5000025700
12	Grease point	25636	5000025636
13	Spanner wrench 46mm	39024	5000039024
14	Inlet pipe puller	305424	5000305424
15	Dead blow hammer	25664	5000029697
16	Seal puller	311444	5000311444
17	Allen T-wrench	26722	5000026722
18	Hook spanner 60-90mm	25777	G276555

## Emulsifier Parts - QuadroCut 225

### QuadroCut 225<sup>®</sup> scansteel foodtech

The scansteel foodtech QuadroCut 225 retrofit kit for Wolfking<sup>®</sup>/ CFS<sup>®</sup>/ GEA<sup>®</sup> emulsifiers, type EcoCut E.225, upgrades your existing emulsifier to be capable of running production with a knife set consisting of three hole plates and four knives.

The scansteel foodtech QuadroCut 225 retrofit kit is fully adaptable to your existing Wolfking<sup>®</sup>/CFS<sup>®</sup>/GEA<sup>®</sup> emulsifier, type EcoCut E.225.



Knife housing shaft for QuadroCut 225



QuadroCut 225 cassette system and QuadroCut 225 knife housing



## Emulsifier Parts - QuadroCut 225 (Cont.)

### Parts Needed for QuadroCut Set-up

Position No.	Description	scansteel foodtech part number	Qty. Needed
1	Driving hub 1 <sup>st</sup> knife set for QuadroCut	43-107	1
2	Driving hub 2 <sup>nd</sup> knife set for QuadroCut	43-116	1
3	Driving hub 3 <sup>rd</sup> knife set for QuadroCut	43-115	1
4	Nut for driving hub M27x2 w=15	43-114	1
5	Nut for driving hub M45x2 w=9	43-113	3
6	Nut for driving hub M48x2 b=9	43-119	2



Knife housing shaft for QuadroCut 225

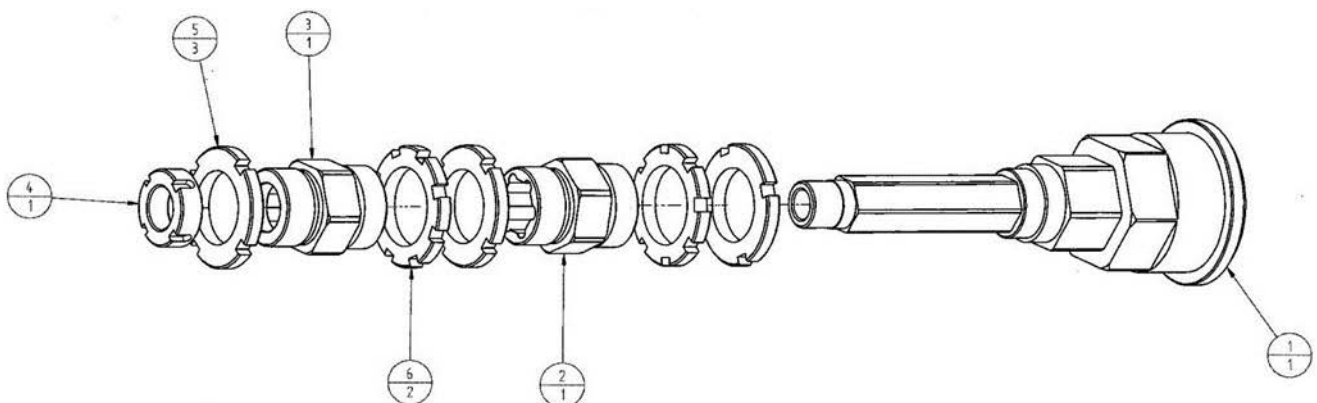

Exploded view of Knife housing shaft for QuadroCut 225

## Simo® Microcutter Parts

Machine Type	Description	Part Number
Simo® Microcutter MC200	Screw for worm pin, M16x50A2	sigr901-200x3511-97
Simo® Microcutter MC200	Teflon wear bush	sigh900-Simo200x50x40x50
Simo® Microcutter MC200	Worm pin type 200 Model 92	sigh900-Simo200x3511-104
Simo® Microcutter MC200	Distance ring 200x40	sigh900-Simo200x3509-146
Simo® Microcutter MC200	Hexagon bush type 46/60	sigh900-Simo200x3502-63
Simo® Microcutter MC200	Thrust block	sigh900-Simo200x3511-26
Simo® Microcutter MC200	Worm, model 92	simx200-200x58-04
Simo® Microcutter MC200	Lining	sigr220-200x3501-92
Simo® Microcutter MC200	Spring	sigh900-Simo200x3511-27
Simo® Microcutter MC200	Support bearing	sigh900-Simo200x3508-44

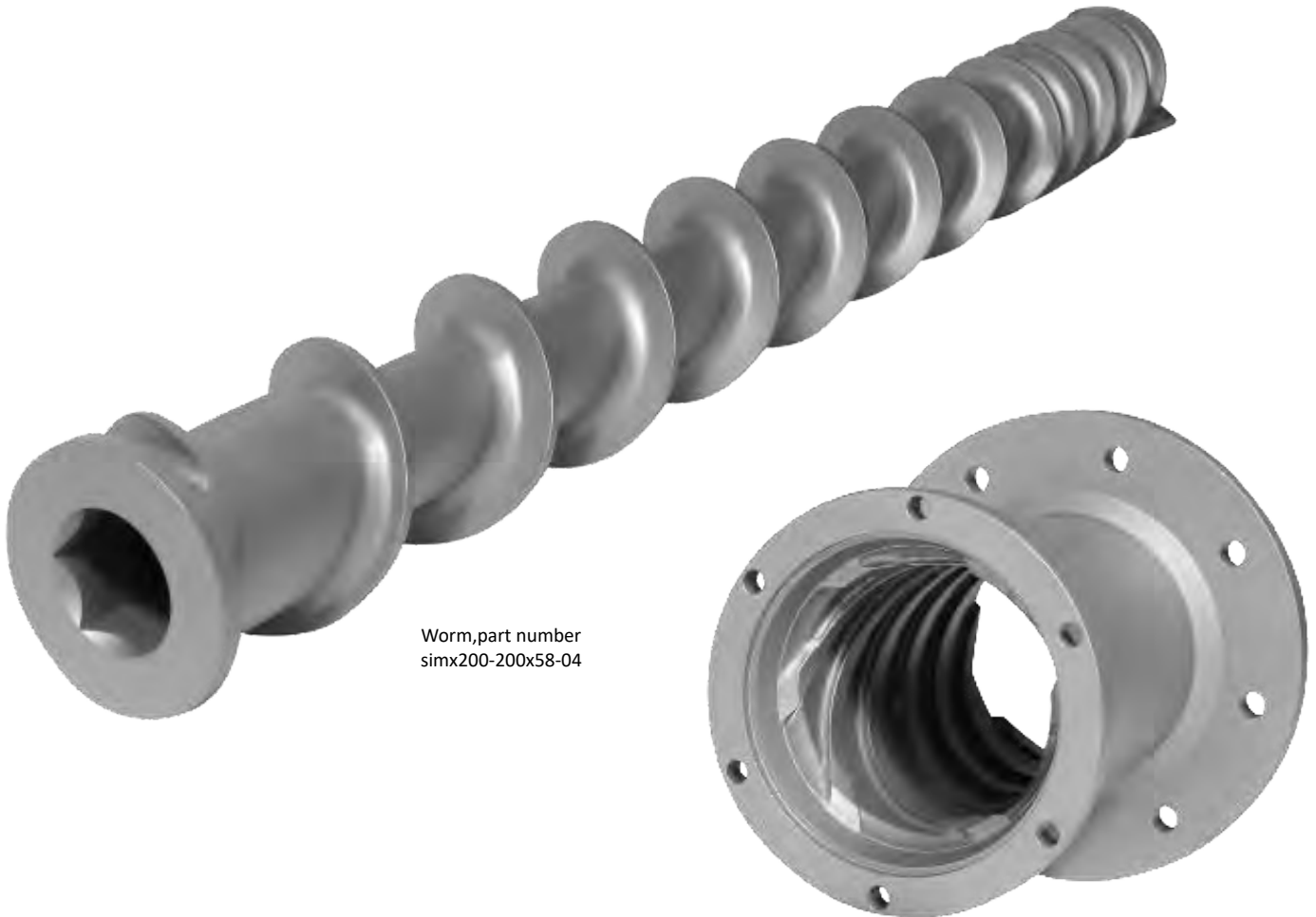

Worm, part number  
simx200-200x58-04

Lining, part number  
sigr220-200x3501-92

[www.koncepttech.com](http://www.koncepttech.com)

Koncept Tech ApS, Industrivej 6, DK-4200 Slagelse, Denmark, Phone: +45 70271410 E-mail: [parts@koncepttech.com](mailto:parts@koncepttech.com)

All items, parts, and accessories listed on the website of Koncept Tech ApS, are manufactured by Koncept Tech ApS, or manufactured to Koncept Tech ApS specifications. The names of the original equipment manufacturers referred to on this site, such as but not limited to: Camitech®, Handtmann®, K&G®, Krämer + Grebe®, CFS®, GEA®, Karl Schnell®, KS®, Laska®, Palma®, Pelsmo®, Seydelmann®, Simo®, Harslev®, Weiler®, Mincomaster®, ANCO®, Cozzini®, The Middleby Corporation®, Wolkling®, Comvair®, Auto®, Beehive®, Yieldmaster®, Meatmaker®, Poss®, Townsend®, Lima®, etc. are all registered trademarks of their respective companies. All original equipment manufacturer's names are listed as Camitech® type, Handtmann® type, K&G® type, Krämer + Grebe® type, CFS® type, Karl Schnell® type, KS® type, Laska® type, Palma® type, Pelsmo® type, Seydelmann® type, Simo® type, Harslev® type, Weiler® type, Mincomaster® type, ANCO® type, Cozzini® type, Wolkling® type, Comvair® type, Auto® type, Beehive® type, Yieldmaster® type, Meatmaker® type®, Poss® type, Townsend® type, Lima® type to indicate that these items are manufactured by Koncept Tech ApS, and not the original equipment manufacturers. Unless specifically stated otherwise, Koncept Tech ApS, has no association or affiliation with any entities/companies listed.

## Simo® Microcutter Parts (Cont.)

Machine Type	Pos. No.	Description	Part Number
Simo® Microcutter MC250/115PFVB150		Worm pin, consisting of:	3511-102
Simo® Microcutter MC250/115PFVB150	1	Tightening nut	3511-101
Simo® Microcutter MC250/115PFVB150	3	Worm pin type 250/115 – long	3511-81
Simo® Microcutter MC250/115PFVB150	4	O-ring, NBR	∅3x∅20
Simo® Microcutter MC250/115PFVB150	5	Tightening screw	3511-100
Simo® Microcutter MC250/115PFVB150	6	Thrust block	3511-20

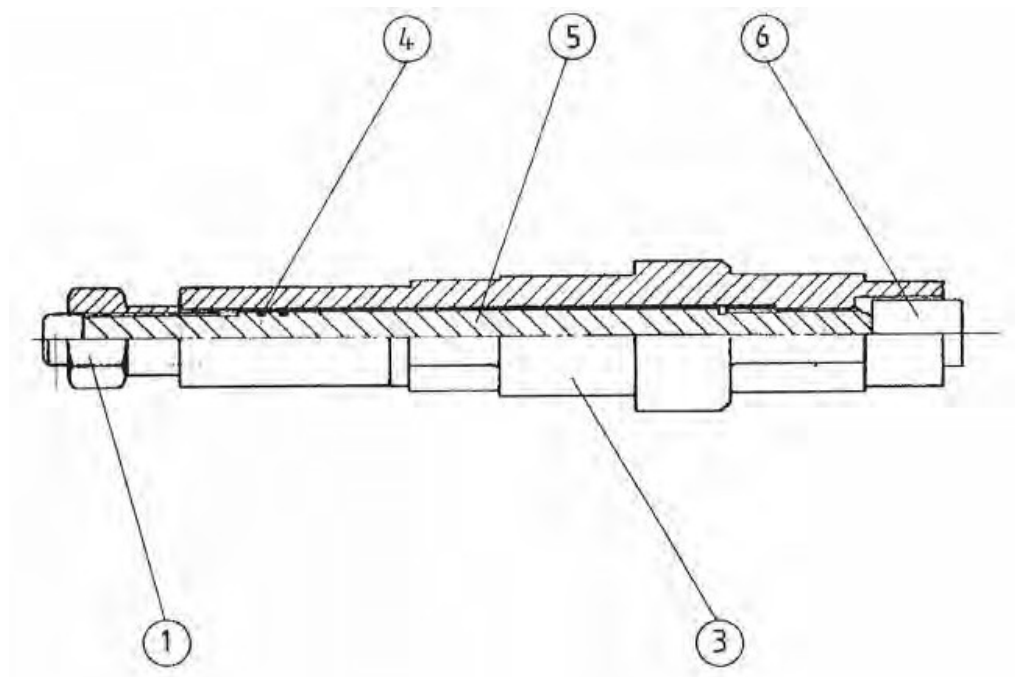

## Simo® Microcutter Parts (Cont.)

Machine Type	Pos. No.	Description	Part Number
Simo® Microcutter MC250/115PFVB150		Double knife set	
Simo® Microcutter MC250/115PFVB150	02	Support bearing type 250LD	3508-97
Simo® Microcutter MC250/115PFVB150	03	Screw cap, type 250	3503-30
Simo® Microcutter MC250/115PFVB150	04	Knife housing	3535-25
Simo® Microcutter MC250/115PFVB150	05	Key way	3535-18
Simo® Microcutter MC250/115PFVB150	06	Bone crushing ring	3505-26
Simo® Microcutter MC250/115PFVB150	08	Sealing for threaded ring	2511-30
Simo® Microcutter MC250/115PFVB150	09	Key way for lining	3501-71
Simo® Microcutter MC250/115PFVB150	10	Lining, type 250/Ø6" lining	3501-107
Simo® Microcutter MC250/115PFVB150	17	Throw off ring	3522-4
Simo® Microcutter MC250/115PFVB150	20	Main bearing, complete	2515-45
Simo® Microcutter MC250/115PFVB150	24	Spacer ring	3511-95
Simo® Microcutter MC250/115PFVB150	25	Threaded ring	3509-12
Simo® Microcutter MC250/115PFVB150	35	Spacer disc for bearing shaft	2505-32

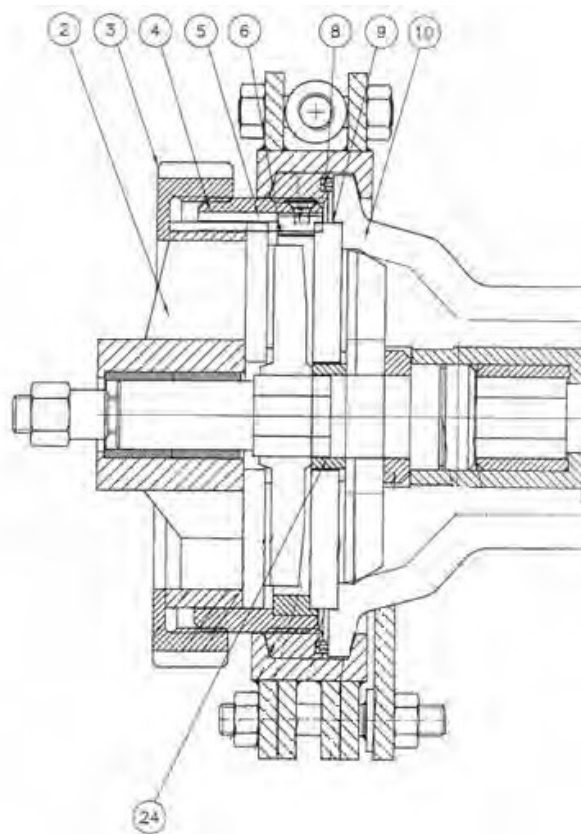

### Simo® Microcutter Parts (Cont.)

Machine Type	Description	Part Number
Simo® Microcutter MC250/300	Main bearing	2515-38 
Simo® Microcutter MC250/300	Worm Short	3502-160 
Simo® Microcutter MC250/300	Lining /125PF	3501-121 
Simo® Microcutter MC250/300	Lining steam injector	3501-00098
Simo® Microcutter MC250/300	Knife housing for bone ring, stainless steel	3505-25
Simo® Microcutter MC250/300	Wear ring Ø140	2511-0000075
Simo® Microcutter MC250/300	Throw off ring	3522-00004
Simo® Microcutter MC250/300	Pilot bearing	3508-97
Simo® Microcutter MC250/300	Bone crushing ring for knife housing	3505-26
Simo® Microcutter MC250/300	Slide bushing	scmm900-1500x2013-05-148K
Simo® Microcutter MC250/300	Planetary gear	313L313
Simo® Microcutter MC250/300	Oil hose	148M1-C-7
Simo® Microcutter MC250/300	Pressure switch	148M1-C-11
Simo® Microcutter MC250/300	New generation oil cooler unit	148M1-C-9
Simo® Microcutter MC250/300	Oil filter	scmc900-250x2013-04-148-M 3623-13-Fla50/9
Simo® Microcutter MC250/300	Solenoid valve	148-M-B1



Main bearing,  
 part number 2515-38 

## Simo® Microcutter Parts (Cont.)

### Main Bearing for MC 250, Part Number 2515-58

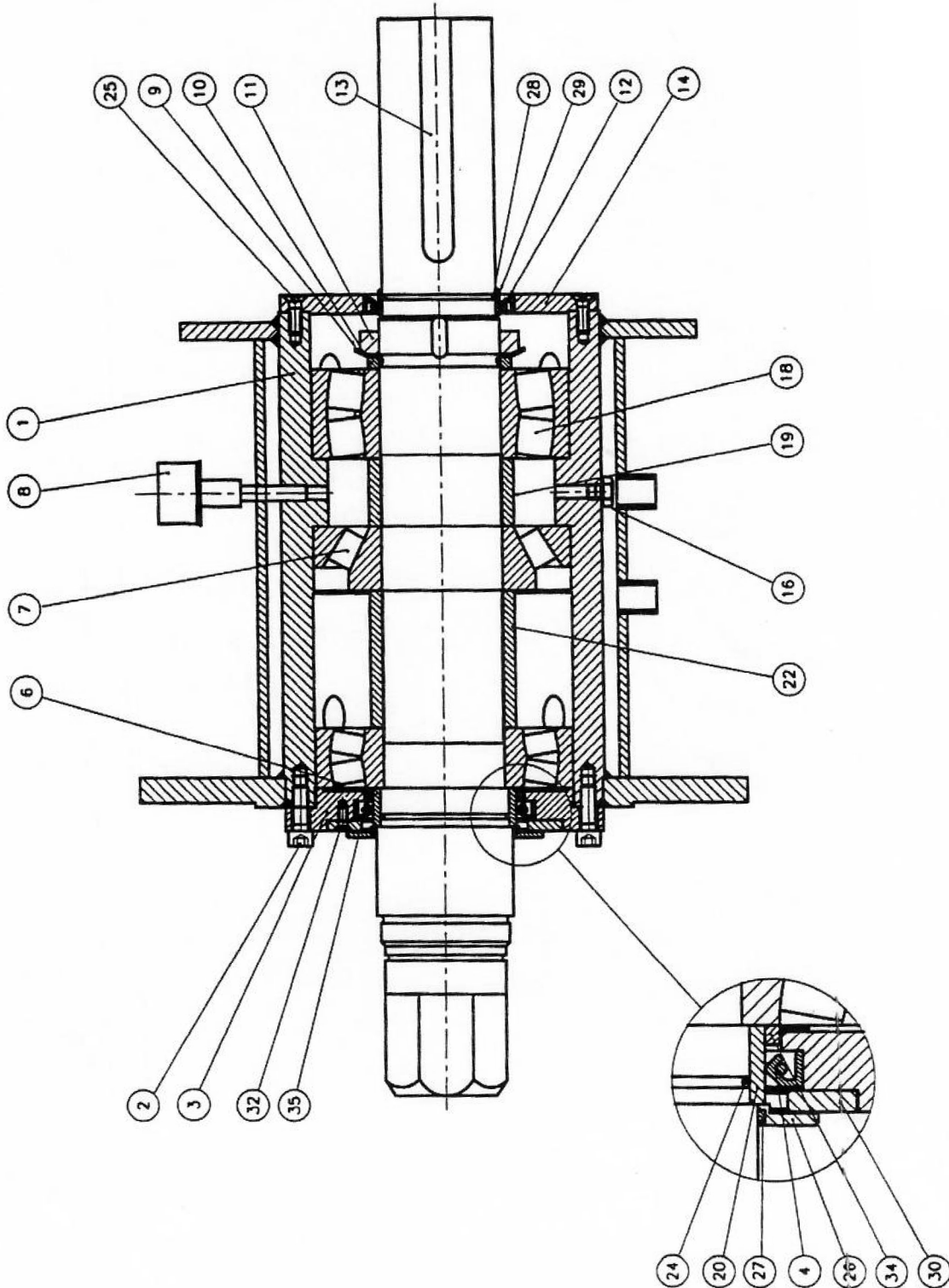

\*To see part list for MC 250 Main Bearing  
please see page no. 86

[www.koncepttech.com](http://www.koncepttech.com)

Koncept Tech ApS, Industrivej 6, DK-4200 Slagelse, Denmark, Phone: +45 70271410 E-mail: [parts@koncepttech.com](mailto:parts@koncepttech.com)

All items, parts, and accessories listed on the website of Koncept Tech ApS, are manufactured by Koncept Tech ApS, or manufactured to Koncept Tech ApS, specifications. The names of the original equipment manufacturers referred to on this site, such as but not limited to: Camilech®, Handtmann®, K&G®, Krämer + Grebe®, CFS®, GEA®, Karl Schnell®, KS®, Laska®, Palma®, Pelsmo®, Seydelmann®, Simo®, Haarslev®, Weiler®, Mincomaster®, ANCO®, Cozzini®, The Middleby Corporation®, Wolfking®, Comvair®, Auto®, Beehive®, Yieldmaster®, Meatmaker®, Poss®, Townsend®, Lima® etc. are all registered trademarks of their respective companies. All original equipment manufacturer's names are listed as Camilech® type, Handtmann® type, K&G® type, Krämer + Grebe® type, CFS® type, Karl Schnell® type, KS® type, Laska® type, Palma® type, Pelsmo® type, Seydelmann® type, Simo® type, Haarslev® type, Weiler® type, Mincomaster® type, ANCO® type, Cozzini® type, Wolfking® type, Comvair® type, Auto® type, Beehive® type, Yieldmaster® type, Meatmaker® type, Poss® type, Townsend® type, Lima® type to indicate that these items are manufactured by Koncept Tech ApS, and not the original equipment manufacturers. Unless specifically stated otherwise, Koncept Tech ApS, has no association or affiliation with any entities/companies listed.

### Simo® Microcutter Parts (Cont.)

#### Part List for Main Bearing for MC 250, Part Number 2515-58

Pos. No	Description	Quantity	Part number
1	Main bearing House	1	2515-56
2	Allen screw M10 x 30	6	5511-41
3	Bearing cap B34/Ø90	1	1221-30
4	Washer 95/120x12	1	6115-95120121
6	Bearing 21316	1	5810-21316
7	Bearing 21316	1	5810-21316
8	Air filter 3/8"	1	3623-14
9	Lock nut MB16	1	5559-7
10	Spacer ring 80/95x8	1	2515-18
11	Lock nut KM16	1	5559-6
12	Washer 80/100x10	1	6315-08010010
13	Key 20x12 L=160	1	7140-2012
14	Bearing cap	1	2506-10
16	Plug 3/8"	1	5715-6
17	Sight glass 3/8"	1	3614-38
18	Bearing 22316	1	5810-22316
19	Spacer ring	1	2507-4
20	Innerring 85/95x26	1	5910-859526

## Simo® Microcutter Parts (Cont.)

### Double Knife Set for MC 250

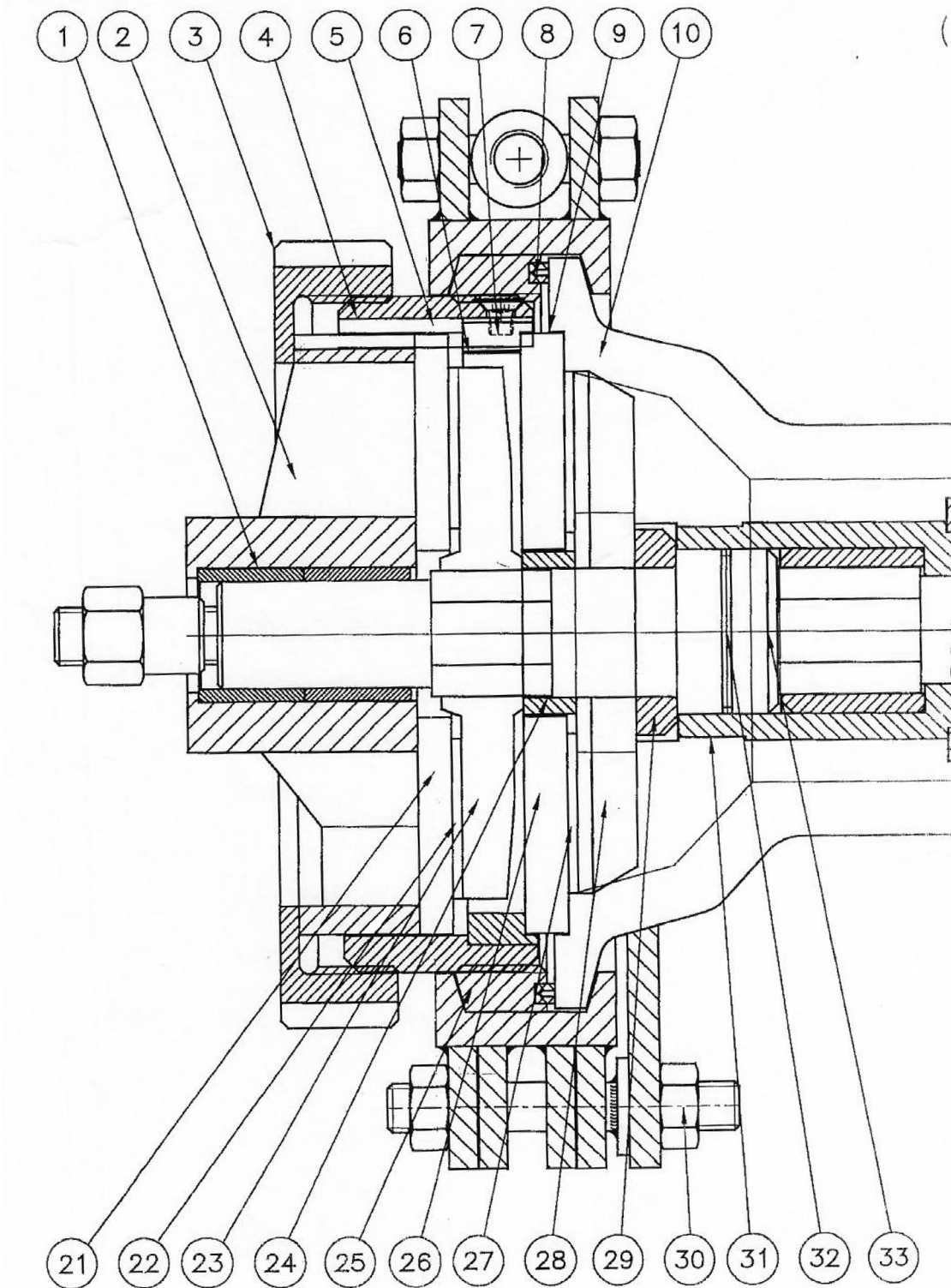

\*To see part list for MC 250 Double Knife Set  
please see page no. 88

[www.koncepttech.com](http://www.koncepttech.com)

Koncept Tech ApS, Industrivej 6, DK-4200 Slagelse, Denmark, Phone: +45 70271410 E-mail: [parts@koncepttech.com](mailto:parts@koncepttech.com)

All items, parts, and accessories listed on the website of Koncept Tech ApS, are manufactured by Koncept Tech ApS, or manufactured to Koncept Tech ApS, specifications. The names of the original equipment manufacturers referred to on this site, such as but not limited to: Camiltech®, Handtmann®, K&G®, Krämer + Grebel®, CFS®, GEA®, Karl Schnell®, KS®, Laska®, Palma®, Pelsmo®, Seydelmann®, Simo®, Haarslev®, Weiler®, Mincomaster®, ANCO®, Cozzini®, The Middleby Corporation®, Wolfking®, Comvair®, Auto®, Beehive®, Yieldmaster®, Meatmaker®, Poss®, Townsend®, Lima®, etc., are all registered trademarks of their respective companies. All original equipment manufacturer's names are listed as Camiltech® type, Handtmann® type, K&G® type, Krämer + Grebel® type, CFS® type, Karl Schnell® type, KS® type, Laska® type, Palma® type, Pelsmo® type, Seydelmann® type, Simo® type, Haarslev® type, Weiler® type, Mincomaster® type, ANCO® type, Cozzini® type, Wolfking® type, Comvair® type, Auto® type, Beehive® type, Yieldmaster® type, Meatmaker® type, Poss® type, Townsend® type, Lima® type to indicate that these items are manufactured by Koncept Tech ApS, and not the original equipment manufacturers. Unless specifically stated otherwise, Koncept Tech ApS, has no association or affiliation with any entities/companies listed.



## Simo® Microcutter Parts (Cont.)

### Part List for Double Knife Set for MC 250 (Part 1 of 2)

Pos. No	Description	Quantity	Part number
1	Bronze Slide Bearing	1	2503-15
2	Support Bearing Type 250LD	1	3508-97
3	Screw Cap Type 250	1	3505-30
4	Knife House Type 250	1	3505-25
5	Key-way	1	3505-18
6	Bone Crushing Ring	1	3505-26
7	UH Screw for Key-way	1	M10x40
8	Sealing f treaded lining L=937	1	2511-30
9	Key-way for Lining	1	3501-71
10	Lining Type 250/Ø6" Inlet	1	3501-107
11	O-ring Sealing	1	Ø4xØ145
12	Spacer Flange	1	3501-84
13	Bush for fitting of Seal	1	1221-32
16	Frame for AES Sealing	1	1221-22
17	Throw off ring	1	3522-4
18	O-ring for Throw off ring	1	Ø3Ø90
19	Ring for Cabinet Cover	1	1219-1
20	Main bearing Complete	1	2515-45
21	Hole Plate / Knife / Precutter	1	Size to be defined
22	Inserts Type 250	1	
23	Knifeholder Type 250 P1-&l	1	
24	Spacer Ring	1	3511-95
25	Threaded Ring	1	3509-12

## Simo® Microcutter Parts (Cont.)

### Part List for Double Knife Set for MC 250 (Part 2 of 2)

Pos. No	Description	Quantity	Part number
26	Hole Plate / Knife / Precutter	1	Size to be defined
27	Inserts Type 250	1	
28	Knifeholder Type 250 P1-&I	1	
29	Thrust Block	1	3511-32
30	Clamping Ring Type 250	1	3504-27
31	Feed Screw	1	3502-160
32	O-ring for Worm Pin	1	Ø3xØ63
33	Worm Pin for MC Type 250/115	1	3511-102
35	Spacer Disc for Bearing Shaft	1	2505-32
35A	Socket Head Screw	2	M6x16
37	Main Bearing Shaft	1	2515-47
38	UH Screw	4	M5x16

## Simo® Microcutter Parts (Cont.)



Worm Short,  
part number 3502-160  



Lining,  
part number 3501-121  



Follow us on LinkedIn



Follow us on Facebook

## Wolfking® / CFS® / GEA® Mixer & Mixer/Grinder Parts

We Supply Parts for the Following Standard Mixers:

Twin Shaft Mixers, Standard		
Wolfking® Brand Name:	CFS® Brand Name:	GEA® Brand Name:
Wolfking® Twin Shaft Mixer, TSM 400	CFS UniMix 400	GEA UniMix 400
Wolfking® Twin Shaft Mixer, TSM 850	CFS UniMix 1000	GEA UniMix 1000
Wolfking® Twin Shaft Mixer, TSM 1250	CFS UniMix 1500	GEA UniMix 1500
Wolfking® Twin Shaft Mixer, TSM 1750	CFS UniMix 2000	GEA UniMix 2000
Wolfking® Twin Shaft Mixer, TSM 2250	CFS UniMix 2500	GEA UniMix 2500
Wolfking® Twin Shaft Mixer, TSM 2750	CFS UniMix 3000	GEA UniMix 3000
Wolfking® Twin Shaft Mixer, TSM 3250	CFS UniMix 3500	GEA UniMix 3500
Wolfking® Twin Shaft Mixer, TSM 4250	CFS UniMix 5000	GEA UniMix 5000

Twin Shaft Mixers, Vacuum		
Wolfking® Brand Name:	CFS® Brand Name:	GEA® Brand Name:
Wolfking® Twin Shaft Mixer Vacuum, TSMV 400	X	X
Wolfking® Twin Shaft Mixer Vacuum, TSMV 850	CFS® UniMix V 1000	GEA® UniMix V 1000
Wolfking® Twin Shaft Mixer Vacuum, TSMV 1250	CFS® UniMix V 1500	GEA® UniMix V 1500
Wolfking® Twin Shaft Mixer Vacuum, TSMV 1750	CFS® UniMix V 2000	GEA® UniMix V 2000
Wolfking® Twin Shaft Mixer Vacuum, TSMV 2250	CFS® UniMix V 2500	GEA® UniMix V 2500
Wolfking® Twin Shaft Mixer Vacuum, TSMV 2750	CFS® UniMix V 3000	GEA® UniMix V 3000
Wolfking® Twin Shaft Mixer Vacuum, TSMV 3250	CFS® UniMix V 3500	GEA® UniMix V 3500
Wolfking® Twin Shaft Mixer Vacuum, TSMV 4250	CFS® UniMix V 5000	GEA® UniMix V 5000



Follow us on LinkedIn

Follow us on Facebook

## Wolfking® / CFS® / GEA® Mixer & Mixer/Grinder Parts (Cont.)

We Supply Parts for the Following Standard Mixers, Intermeshing:

### Twin Shaft Mixers, Intermeshing

Wolfking® Brand Name:	CFS® Brand Name:	GEA® Brand Name:
Wolfking® Twin Shaft Mixer, Intermeshing TSMI 1000	CFS® UniMix I 1000	GEA® UniMix I 1000
Wolfking® Twin Shaft Mixer, Intermeshing TSMI 1500	CFS® UniMix I 1500	GEA® UniMix I 1500
Wolfking® Twin Shaft Mixer, Intermeshing TSMI 2000	CFS® UniMix I 2000	GEA® UniMix I 2000
Wolfking® Twin Shaft Mixer, Intermeshing TSMI 2500	CFS® UniMix I 2500	GEA® UniMix I 2500
Wolfking® Twin Shaft Mixer, Intermeshing TSMI 3000	CFS® UniMix I 3000	GEA® UniMix I 3000
Wolfking® Twin Shaft Mixer, Intermeshing TSMI 3500	CFS® UniMix I 3500	GEA® UniMix I 3500
Wolfking® Twin Shaft Mixer, Intermeshing TSMI 5000	CFS® UniMix I 5000	GEA® UniMix I 5000

### Twin Shaft Mixers, Intermeshing, Vacuum

Wolfking® Brand Name:	CFS® Brand Name:	GEA® Brand Name:
Wolfking® Twin Shaft Mixer, Intermeshing, Vacuum TSMIV 1000	CFS® UniMix I 1000	GEA® UniMix I 1000
Wolfking® Twin Shaft Mixer, Intermeshing, Vacuum TSMIV 1500	CFS® UniMix I 1500	GEA® UniMix I 1500
Wolfking® Twin Shaft Mixer, Intermeshing, Vacuum TSMIV 2000	CFS® UniMix I 2000	GEA® UniMix I 2000
Wolfking® Twin Shaft Mixer, Intermeshing, Vacuum TSMIV 2500	CFS® UniMix I 2500	GEA® UniMix I 2500
Wolfking® Twin Shaft Mixer, Intermeshing, Vacuum TSMIV 3000	CFS® UniMix I 3000	GEA® UniMix I 3000
Wolfking® Twin Shaft Mixer, Intermeshing, Vacuum TSMVI 3500	CFS® UniMix I 3500	GEA® UniMix I 3500
Wolfking® Twin Shaft Mixer, Intermeshing, Vacuum TSMIV 5000	CFS® UniMix I 5000	GEA® UniMix I 5000

## Wolfking® / CFS® / GEA® Mixer & Mixer/Grinder Parts (Cont.)

### Parts for Type: SSM/TSM/TSMV/TSMG/TSMI/TSMIV/TSMIG from 400 L to 7250 L

- Conical shafts
- Shaft sealing sets
- Sealings for discharge gate(s)
- Lid sealings
- Bearing pins for mixing wings
- Machine shoes
- For mixers/grinders -> As per above and see parts for grinders

Conial Shaft		
Machine Type	Description	Part Numer
Wolfking® SSM 1500		5000030274 30274
Wolfking® TSM/TSMV/ TSMG/TSMI/TSMIV/TSMIG CFS® UniMix GEA® UniMix		5000032690 ✓ 36290 ✓
Wolfking® TSM1250 CFS® UniMix 1500 GEA® UniMix 1500		5000036068 ✓ 36068 ✓
Wolfking® TSM 600		5000030276 ✓ 30276 ✓
Wolfking® TSMG 1000		5000030272 30272
Wolfking® TSM 1500		500030273 30273
Wolfking® TSMG 2750		50000310278 ✓ 310278 ✓
Wolfking® TSM1250 Wolfking® TSMI 1250 Wolfking® TSMIG 1250		5000037444 37444
	Shaft with cone, drive end	32371
Wolfking® TSMV 1750		37682
	1 Cone shaft driven, stainless steel	39281
	Shaft with cone, drive end L=550	36693

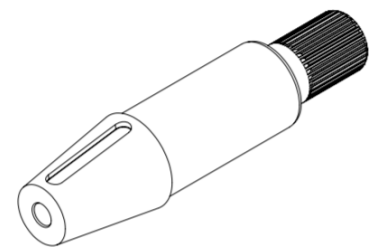

Conical shaft

### Wolfking® / CFS® / GEA® Mixer & Mixer/Grinder Parts (Cont.)

Description	Machine Type	Part Number
Tightening fillet for outlet gate	Wolfking® TSM/TSMV/	wkmx926-x23522
	TSMG/TSMI/TSMIV/TSMIG	5000023522
	CFS® UniMix GEA® UniMix	23522



Tightening fillet for outlet gate, part number wkmx926-x23522 5000023522 / 23522

Description	Machine Type	Part Number
Lid sealing	Wolfking® TSM/TSMV/	wkmx926-x07S123T10810
	TSMG/TSMI/TSMIV/TSMIG	5000023491
	CFS® UniMix	23491
	GEA® UniMix	5000374718 374718



Lid sealing, part number wkmx926-x07S123T10810 5000023491 / 23491 5000374718 / 374718

Description	Machine Type	Part Number
Bearing pin for mixing wing	Wolfking® TSM 1250	5000036072
	CFS® UniMix 1500	36072
	GEA® UniMix1500	
	Wolfking® TSM 1750	5000036690
	CFS® UniMix 1500	36690
	GEA® UniMix1500	



Bearing pin for mixing wing, part number 5000036072 / 36072

Description	Machine Type	Part Number
Machine shoes	Wolfking® TSM/TSMV/ TSMG/TSMI/TSMIV/TSMIG CFS® UniMix GEA® UniMix	N/A



## Wolfking® / CFS® / GEA® Mixer & Mixer/Grinder Parts - Mixing Wing Seal Assembly

### Shaft Sealing Blue for Mixing Wing



Shaft sealing, split model  
 part number 5000383727 ✓/383727 ✓  
 (O-seal NOT included)



Shaft sealing, split model,  
 part number 5000373015 ✓/373015 ✓ (O-seal NOT included)

Machine Type	Description	Part Number
Wolfking® TSM/TSMV/ TSMG/TSMI/TSMIV/TSMIG CFS® UniMix GEA® UniMix	Ø70 mm shaft sealing. Split model for easy mounting, consisting of blue POM. (O-seal NOT included)	5000373015 ✓ 373015 ✓
Wolfking® TSM/TSMV/ TSMG/TSMI/TSMIV/TSMIG CFS® UniMix GEA® UniMix	Ø100 mm shaft sealing. Split model for easy mounting, consisting of blue POM. (O-seal NOT included)	5000383727 ✓ 383727 ✓
Wolfking® TSM/TSMV/ TSMG/TSMI/TSMIV/TSMIG CFS® UniMix GEA® UniMix	O-seal set for Ø70 (1 x glue, 2 x tools and 8 x sealings) consisting of blue POM	wkmx926-xØ93 ✓
Wolfking® TSM/TSMV/ TSMG/TSMI/TSMIV/TSMIG CFS® UniMix GEA® UniMix	O-seal set for Ø100 (1 x glue, 2 x tools and 8 x sealings) consisting of blue POM	wkgr926-xØ118 ✓



O-seal set , (1 x glue, 2 x tools and 8 x sealings), part number wkmx926-xØ93 ✓ +118 ✓  
 for part number 5000373015 ✓/ 373015 ✓ and 5000383727 ✓/383727 ✓



## Wolfking® / CFS® / GEA® Mixer & Mixer/Grinder Parts - Mixing Wing Seal Assembly

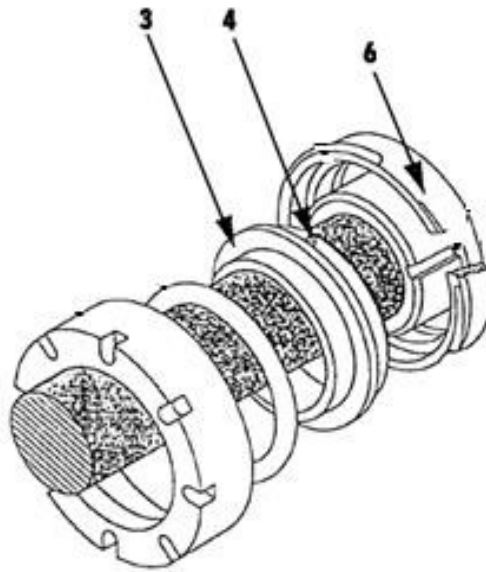







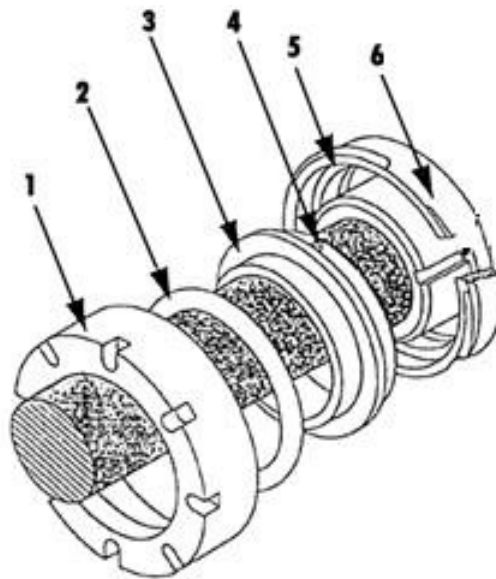

Mixing Wing Seal Assembly for Wolfking® TSMV850 only

Machine Type	Pos. No.	Description	Part Number
Wolfking® TSMV850	03	Shaft sealing	wkmx900-850x33545
Wolfking® TSMV850	04	Bearing pin	wkmx900-850x37036
Wolfking® TSMV850	06	Bushing for Ø58 shaft sealing	wkmx900x850x33541
Wolfking® TSMV850		Cone.driving shaft, stainless steel	wkmx900-x30676
Wolfking® TSMV850		O-seal set Ø70 small for 373015 (8x 1 seal + 1 x glue + 2 x assemblytool)	wkmx9267-xØ93
Wolfking® TSMV850		Gear ED 2045 21.1:1 Ø65	wkmx900x850xED2045
Wolfking® TSMV850		Bushing for mixing wing	wkmx900x850x37035

## Wolfking® / CFS® / GEA® Mixer & Mixer/Grinder Parts - Mixing Wing Seal Assembly



Mixing Wing Seal Assembly

Machine Type	Pos. No.	Description	Part Number
Wolfking® TSM/TSMV/ TSMG/TSMI/TSMIV/TSMIG CFS® UniMix GEA® UniMix	01	Screw cap	5000034006  34006 
Wolfking® TSM/TSMV/ TSMG/TSMI/TSMIV/TSMIG CFS® UniMix GEA® UniMix	02	Tightening hose Ø100	5000033556 33556
Wolfking® TSM/TSMV/ TSMG/TSMI/TSMIV/TSMIG CFS® UniMix GEA® UniMix	03	Shaft sealing	50000033557  33557  5000383727  383727 
Wolfking® TSM/TSMV/ TSMG/TSMI/TSMIV/TSMIG CFS® UniMix GEA® UniMix	04	Pin, stainless steel, 5x10	5000026621  26621 
Wolfking® TSM/TSMV/ TSMG/TSMI/TSMIV/TSMIG CFS® UniMix GEA® UniMix	05	Housing	5000033554  33554 
Wolfking® TSM/TSMV/ TSMG/TSMI/TSMIV/TSMIG CFS® UniMix GEA® UniMix	06	Bushing	5000033553  33553 

### Wolfking® / CFS® / GEA® / Simo® Pump Parts

#### Simo® Type Pumps Model 200, 250, 290

Description	Part Number DC 200	Part Number DC 250	Part Number DC 290
Drive hub	0120-89	0120-285	0120-934
Stay bolt	0120-87H	0120-212H	0120-236H
Nut for stay bolt	0120-463	0120-202H	0120-202H
Impeller (1 set = 7 pcs.)	0120-75H	0120-199H	0120-247H
Wear plate, lining end	0120-292H	0120-293H	0120-385H
Wear plate, bearing end	0120-295H	0120-296H	0120-297H
Center cam	0120-76	0120-101	0120-145
Center cam HD pur/steel	N/A	N/A	0120-0145Pur
Allen screw	otmm901-xm16x130	xallenm16x160	290xUnbraco16x200
Bronze bushing 80/90x100	N/A	9003-0209	9003-0209
Pump housing	0120-71	0120-204	0120-139H
Axle journal	0120-251H	0120-211H	0120-664H
Pump worm	0120-649	0120-600	0120-639
Gear	ED2065	25001	25004
Seal cap f/UM sealing	N/A	N/A	2511-000076
Stay bolt f/pump housing	0120-268	0120-268	0120-279

HD = Heavy Duty



Pump housings 200, 250, and 290,  
part number 0120-71 , 0120-204 , 0120-139H

## Wolfking® / CFS® / GEA® / Simo® Pump Parts (Cont.)

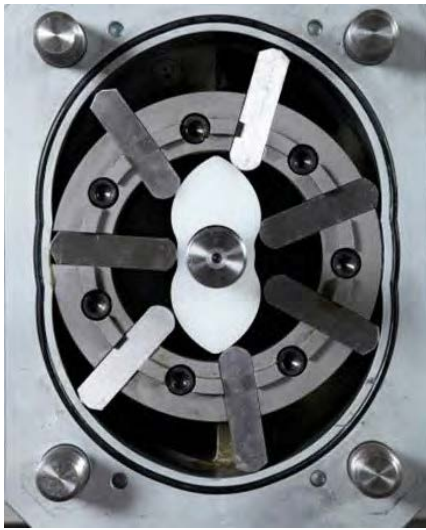

Pump housing,  
 partnumber 0120-71 , 0120-204   
 0120-139H



Center cam for 200, 250, and 290,  
 partnumber 0120-76 , 0120-101 ,  
 0120-145   
 Allen screw  
 part number otmm901-xm16x130   
 xallenm16x160 , 290xUnbraco16x200



Drive hub,  
 part number 0120-89 ,  
 0120-285 , 0120-934



Impellers for 200, 250, 290 (1 set= 7 pcs.),  
 partnumber 0120-75H , 0120-199H ,  
 0120-247H



Axle journal,  
 part number 0120-251H ,  
 0120-211H , 0120-664H



Center cam HD for 290, pur/steel  
 partnumber 0120-0145Pur



Stay bolt for drive hub,  
 partnumber 0120-87H ,  
 0120-212H , 0120-236H



Wear plate, bearing end,  
 partnumber 0120-295H ,  
 0120-296H , 0120-297H



Wear plate, lining end,  
 partnumber 0120-292H ,  
 0120-293H , 0120-385H

## Wolfking® / CFS® / GEA® / Simo® Pump Parts



Front cover for pump, part number 0120-233 ✓



Bronze bushing 80/90x100  
Part number 9003-0209 ✓



Stay bolt for pump housing,  
part number 0120-268, 0120-279 ✓



Pump worm for 290 Pump,  
part number 0120-639 ✓

### Pump head Assembly

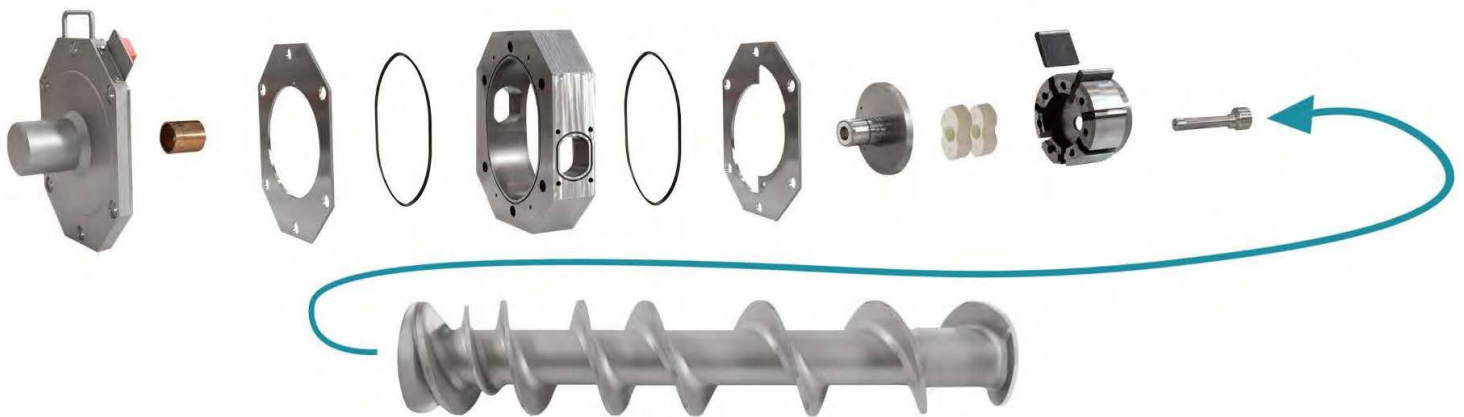



Follow us on LinkedIn

Follow us on Facebook

## Wolfking® / CFS® / GEA® Pump Parts - CFD Unit

### Parts list for Wolfking®/CFS®/SIMO®/GEA® CFD MD85 - Wolfking® C.250 & Wolfking® SFG 1500/250

Position No.	Description	Part Number
1	Suction gate for Contiflow	36335/315657
2	Pressure gate for Contiflow	37134
3	Bushing (pressure gate)	30379
4	Wear ring for pressure gate	35765
5	Wear ring for suction gate	35545
6	Part for drive hub for CFD	30568
7	Worm pin	30227
8	Bushing for part of driving hub	30672/314352
9	Pump housing 16 m3	"32850/35548 317680"
10	Pallets (1 set = 2 pcs.)	38546
11	inserts for pallets (1 set = 4 pcs) - Plastic	34468/41494
10	Palette system for HD execution (1 set = 2 pcs)	37696
11	Loose inserts for pallets HD execution metal (1 set = 4 pcs.)	37697
12	Drive hub CFD II-III model 85	30569/317627
13	Bushing (Drive hub)	30673/314354
14	Thrust ring for CFD, stainless steel	30622
15	Bearing bushing for suction gate	30380
16	Axial bearing for suction gate for CFD	30381
16	Axial bearing for suction gate for CFD - NEW VERSION	314355
17	Handle for fixtures, stainless steel for CFD	30510
18	O-ring 304mm x 3mm, pressure gate	23250
19	O-ring 249,3mm x 5,7mm, pressure gate	23348

[www.koncepttech.com](http://www.koncepttech.com)

Koncept Tech ApS, Industrivej 6, DK-4200 Slagelse, Denmark, Phone: +45 70271410 E-mail: [parts@koncepttech.com](mailto:parts@koncepttech.com)

All items, parts, and accessories listed on the website of Koncept Tech Aps, are manufactured by Koncept Tech Aps, or manufactured to Koncept Tech Aps, specifications. The names of the original equipment manufacturers referred to on this site, such as but not limited to: Camilech®, Handtmann®, K&G®, Krämer + Grebe®, CFS®, GEA®, Karl Schnell®, KS®, Laska®, Palma®, Pelsmo®, Seydelmann®, Simo®, Haarslev®, Weiler®, Mincmaster®, ANCO®, Cozzini®, The Middleby Corporation®, Wolfking®, Comvair®, Auto®, Beehive®, Yieldmaster®, Meatmaker®, Poss®, Townsend®, Lima®, etc., are all registered trademarks of their respective companies. All original equipment manufacturer's names are listed as Camilech® type, Handtmann® type, K&G® type, Krämer + Grebe® type, CFS® type, Karl Schnell® type, KS® type, Laska® type, Palma® type, Pelsmo® type, Seydelmann® type, Simo® type, Haarslev® type, Weiler® type, Mincmaster® type, ANCO® type, Cozzini® type, Wolfking® type, Comvair® type, Auto® type, Beehive® type, Yieldmaster® type, Meatmaker® type, Poss® type, Townsend® type, Lima® type to indicate that these items are manufactured by Koncept Tech Aps, and not the original equipment manufacturers. Unless specifically stated otherwise, Koncept Tech Aps, has no association or affiliation with any entities/companies listed.

## Wolfking® / CFS® / GEA® Pump Parts - CFD Unit(Cont.)

### Exploded View of Wolfking®/CFS®/SIMO®/GEA® CFD MD85 - Wolfking® C.250 & Wolfking® SFG 1500/250

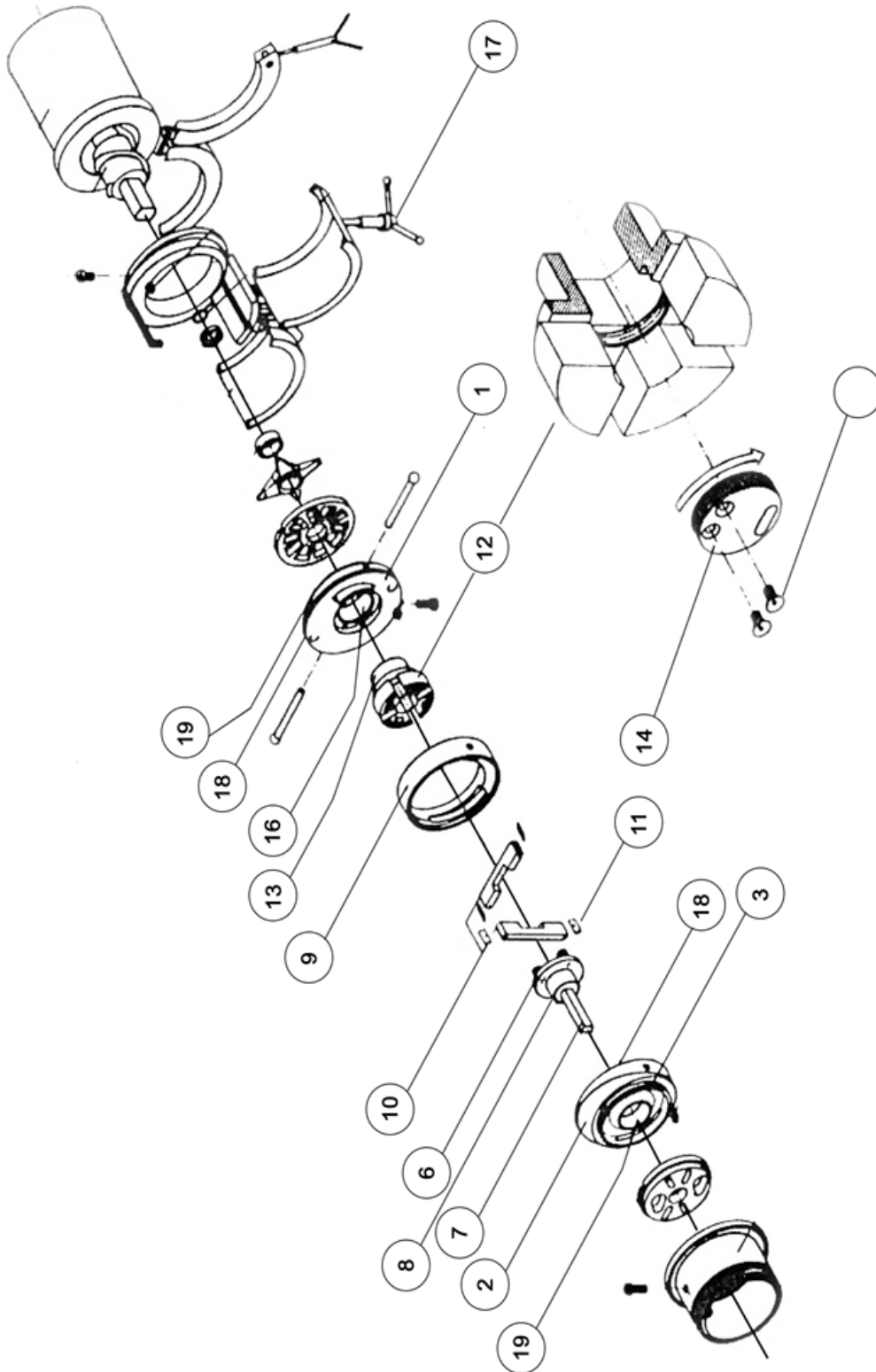

[www.koncepttech.com](http://www.koncepttech.com)

Koncept Tech ApS, Industrivej 6, DK-4200 Slagelse, Denmark, Phone: +45 70271410 E-mail: [parts@koncepttech.com](mailto:parts@koncepttech.com)

All items, parts, and accessories listed on the website of Koncept Tech ApS, are manufactured by Koncept Tech ApS, or manufactured to Koncept Tech ApS specifications. The names of the original equipment manufacturers referred to on this site, such as but not limited to: Camilech®, Handlmann®, K&G®, Krämer + Grebe®, CFS®, GEA®, Karl Schnell®, KS®, Laska®, Palma®, Pelmo®, Seydelmann®, Simo®, Harslev®, Weiler®, Mincomaster®, ANCO®, Cozzini®, The Middleby Corporation®, Wolfking®, Comvair®, Auto®, Beehive®, Yieldmaster®, Meatmaker®, Poss®, Townsend®, Lima® etc. are all registered trademarks of their respective companies. All original equipment manufacturer's names are listed as Camilech® type, Handlmann® type, K&G® type, Krämer + Grebe® type, CFS® type, Karl Schnell® type, KS® type, Laska® type, Palma® type, Pelmo® type, Seydelmann® type, Simo® type, Harslev® type, Weiler® type, Mincomaster® type, ANCO® type, Cozzini® type, Wolfking® type, Comvair® type, Auto® type, Beehive® type, Yieldmaster® type, Meatmaker® type, Poss® type, Townsend® type, Lima® type to indicate that these items are manufactured by Koncept Tech ApS, and not the original equipment manufacturers. Unless specifically stated otherwise, Koncept Tech ApS, has no association or affiliation with any entities/companies listed.



Follow us on LinkedIn

Follow us on Facebook

## Wolfking® / CFS® / GEA® Pump Parts - Contiflow Pump

### Parts list for Wolfking®/CFS®/SIMO®/GEA® Contiflow pump - Stand alone

Position No.	Description	Part Number
1	Suction gate for Contiflow	36335/315657
2	Pressure gate for Contiflow	37134
3	Bushing (pressure gate)	30379
4	Wear ring for pressure gate	35765
5	Wear ring for suction gate	35545
6	Part for drive hub for CFD	35594
7	Bushing for part of driving hub	30672/314352 32850/35548
8	Pump housing 16 m3	317680
9	Pallets (1 set = 2 pcs.)	38546
10	Inserts for pallets (1 set = 4 pcs) - Plastic	34468/41494
9	Palette system for HD execution (1 set = 2 pcs)	37696
10	Loose inserts for pallets HD execution metal (1 set = 4 pcs.)	37697
11	Drive hub CFD II-III model 85	30569/317627
12	Bushing (Drive hub)	30673/314354
13	Thrust ring for CFD, stainless steel	30622
14	Bearing bushing for suction gate	30380
15	Axial bearing for suction gate for CFD	30381
15	Axial bearing for suction gate for CFD - NEW VERSION	314355
16	Outlet nozzle 4", for Contiflow	37455/320169
	Main bearing	310858
	Drive shaft for main bearing	35576
	Gear, planetary EM1045	25028



## Wolfking® / CFS® / GEA® Pump Parts - Contiflow Pump (Cont.)

### Parts list for Wolfking® / CFS® / GEA® Contiflow Pump (Part 3 of 3)

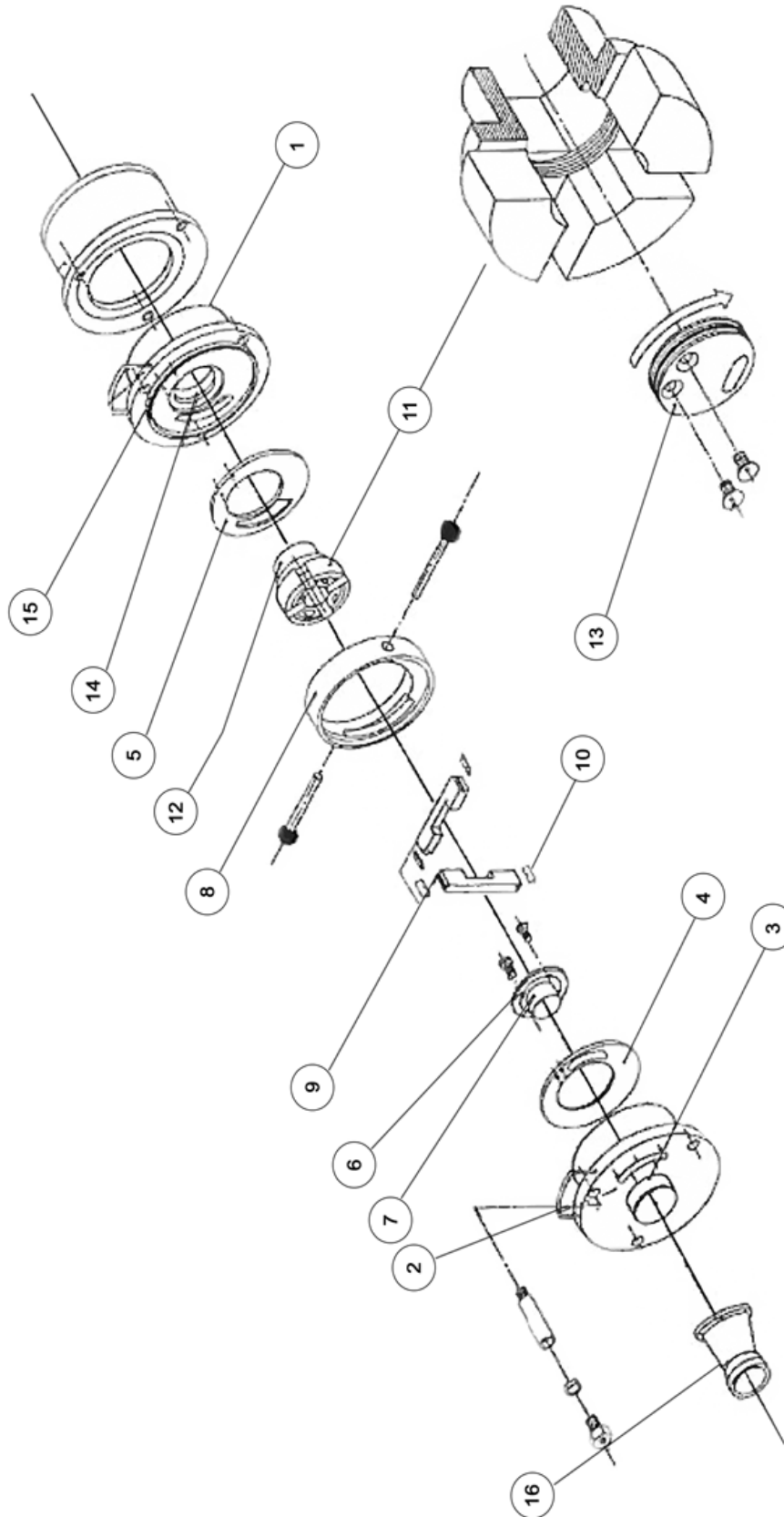

[www.koncepttech.com](http://www.koncepttech.com)

Koncept Tech ApS, Industrivej 6, DK-4200 Slagelse, Denmark, Phone: +45 70271410 E-mail: [parts@koncepttech.com](mailto:parts@koncepttech.com)

All items, parts, and accessories listed on the website of Koncept Tech ApS, are manufactured by Koncept Tech ApS, or manufactured to Koncept Tech ApS, specifications. The names of the original equipment manufacturers referred to on this site, such as but not limited to: Camiltech®, Handlmann®, K&G®, Krämer + Grebe®, CFS®, GEA®, Karl Schnell®, KS®, Laska®, Palma®, Peltsmo®, Seydelmann®, Simo®, Harslev®, Weller®, Mincmaster®, ANCO®, Cozzini®, The Middleby Corporation®, Wolfking®, Comvair®, Auto®, Beehive®, Yieldmaster®, Meatmaker®, Poss®, Townsend®, Lima®, etc. are all registered trademarks of their respective companies. All original equipment manufacturer's names are listed as Camiltech® type, Handlmann® type, K&G® type, Krämer + Grebe® type, CFS® type, Karl Schnell® type, KS® type, Laska® type, Palma® type, Peltsmo® type, Seydelmann® type, Simo® type, Harslev® type, Weller® type, Mincmaster® type, ANCO® type, Cozzini® type, Wolfking® type, Comvair® type, Auto® type, Beehive® type, Yieldmaster® type, Meatmaker® type, Poss® type, Townsend® type, Lima® type to indicate that these items are manufactured by Koncept Tech ApS, and not the original equipment manufacturers. Unless specifically stated otherwise, Koncept Tech ApS, has no association or affiliation with any entities/companies listed.

## Wolfking® / CFS® / GEA® Pump Parts - Contiflow Pump 250 & Vane Pump SF & DF



Loose insert for pallets in metal (1 set=4pcs.),  
part number 5000037697 ✓/37697 ✓



Pallet  
part number 5000038546 ✓/38546 ✓

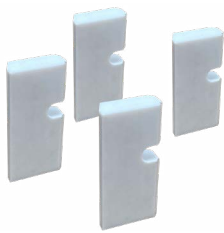

Plastic insert for pallets (set=4pcs.), part  
number 5000034468 ✓/34468 ✓

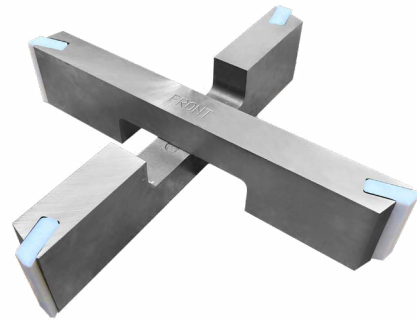

Pallets HD for Contiflow (set=2 pcs.)



Side plate/pressure part CFD, stainless steel



Various Contiflow 250 pump parts





Thrust ring for CFD, stainless steel  
part number 5000030622/30622 ✓

HD = Heavy Duty

## Wolfking® / CFS® / GEA® Pump Parts - Contiflow Pump 250 & Vane Pump SF & DF (Cont.)





Bushing for part of driving hub  
part number 5000030672  /30672 





Bushing  
part number 50000314354 / 314354



Bushing for suction gate  $\varnothing 130 \times \varnothing 120 \times 53$   
part number 5000030381  /30381 



Bushing for pressure gate  
5000030379  / 30379 



Wear ring for pressure gate  
part number 5000035765/35765 



Wear ring for suction gate  
part number 5000035545/35545 

## Wolfking® / CFS® / GEA® Pump Parts - Contiflow Pump 250 & Vane Pump SF & DF (Cont.)



Rear hub for Contiflow pump – seen from the side  
part number 5000030569 / 30569 , 5000317627 / 317627 



Rear hub for Contiflow pump – seen from the bottom  
part number 5000030569 / 30569 , 5000317627 / 317627 

## Wolfking®/CFS®/SIMO®/GEA® CFD MD85 - Wolfking® C.250 & Wolfking® SFG 1500/250

\*Part seen below of drive hub is only compatible with the CFD type pump which is build on the grinder  
- NOT for "Stand alone" pump type. Please view drawing page 102, pos. 6 + 7 + 8.





Part of drive hub - seen from different views  
part number 30569 

## Wolfking® / CFS® / GEA® Pump Parts - Contiflow Pump (Stand Alone)

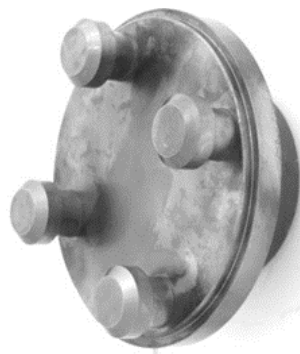
\*Part of drive hub is only compatible with the Contiflow type pump "Stand alone".  
Please view drawing page 105, pos. 9.



Part of drive hub,  
part number 5000035594 /35594 

[www.koncepttech.com](http://www.koncepttech.com)

Koncept Tech ApS, Industrivej 6, DK-4200 Slagelse, Denmark, Phone: +45 70271410 E-mail: [parts@koncepttech.com](mailto:parts@koncepttech.com)





All items, parts, and accessories listed on the website of Koncept Tech ApS, are manufactured by Koncept Tech ApS, or manufactured to Koncept Tech ApS, specifications. The names of the original equipment manufacturers referred to on this site, such as but not limited to: Camilech®, Handlmann®, K&G®, Krämer + Grebe®, CFS®, GEA®, Karl Schnell®, KS®, Laska®, Palma®, Pelsmo®, Seydelmann®, Simo®, Harslev®, Weiler®, Mincmaster®, ANCO®, Cozzini®, The Middleby Corporation®, Wolfking®, Comvair®, Auto®, Beehive®, Yieldmaster®, Meatmaker®, Poss®, Townsend®, Lima® etc. are all registered trademarks of their respective companies. All original equipment manufacturer's names are listed as Camilech® type, Handlmann® type, K&G® type, Krämer + Grebe® type, CFS® type, Karl Schnell® type, KS® type, Laska® type, Palma® type, Pelsmo® type, Seydelmann® type, Simo® type, Harslev® type, Weiler® type, Mincmaster® type, ANCO® type, Cozzini® type, Wolfking® type, Comvair® type, Auto® type, Beehive® type, Yieldmaster® type, Meatmaker® type®, Poss® type, Townsend® type, Lima® type to indicate that these items are manufactured by Koncept Tech ApS, and not the original equipment manufacturers. Unless specifically stated otherwise, Koncept Tech ApS, has no association or affiliation with any entities/companies listed.

## Wolfking® / CFS® / GEA® Pump Parts - Contiflow Pump 250 & Vane Pump SF & DF (Cont.)



Suction Gate  
part number 315657 



Pump housing for CFD 16 m<sup>3</sup>  
part number 5000032850  / 32850 , 5000035548  / 35548 , 50000317860  / 317860



Drive hub with pallet system





Follow us on LinkedIn



Follow us on Facebook

## Wolfking® / CFS® CAP 12 Pump

Machine Type	Description	Part Number
Wolfking® CAP 12 CFS® CAP 12	Drive hub 12m3 pump	5000407783 407783 5000039090 39090
Wolfking® CAP 12 CFS® CAP 12	Pumpring for 12m3 pump	5000360222 360222
Wolfking® CAP 12 CFS® CAP 12	Pumpring for 12m3 pump	5000360223 360223

## Cozzini® Pump Parts - Type Vane Pump Parts

### Exploded View of Cozzini® Type Vane Pump

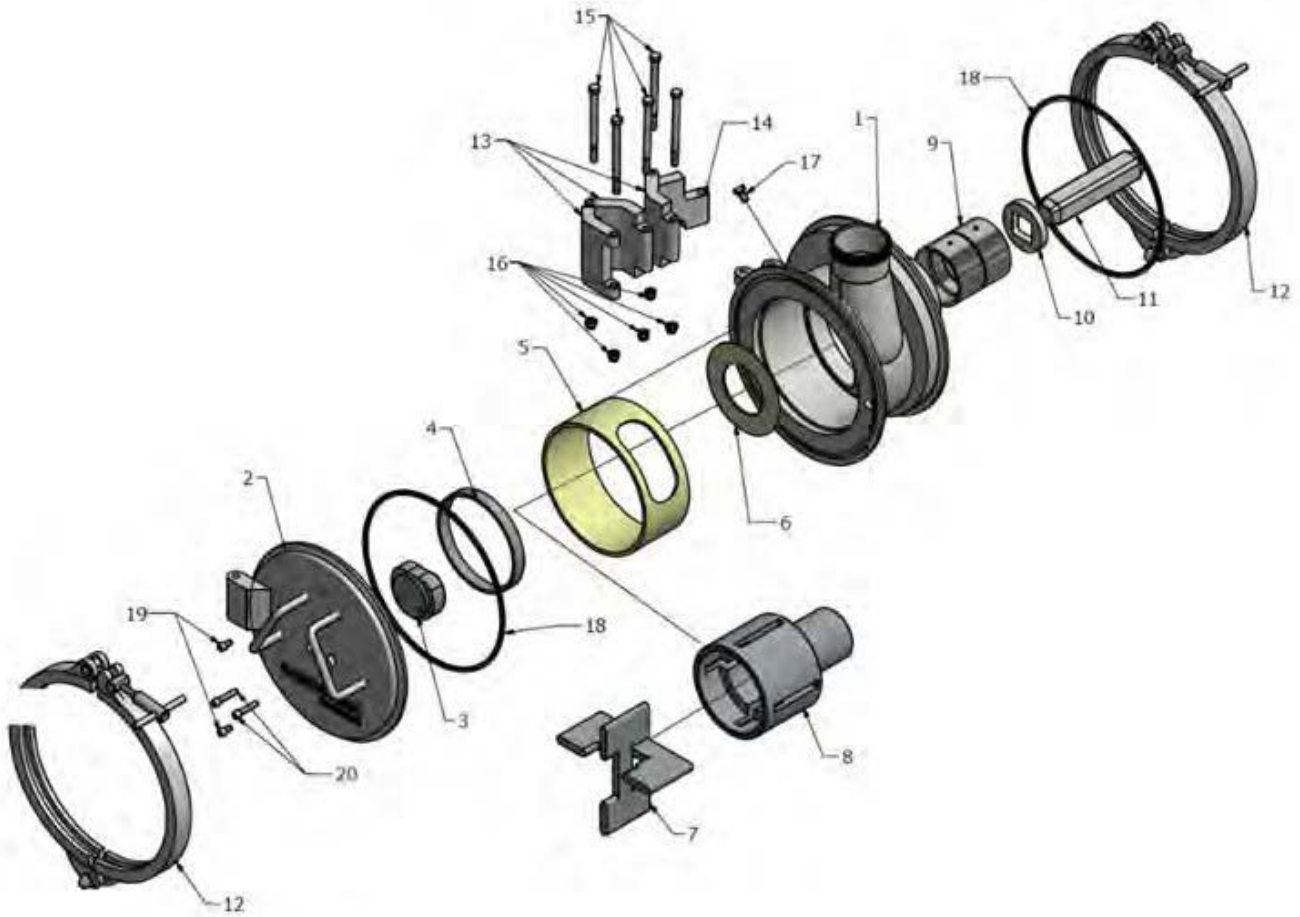

## Cozzini® Pump Parts - Type Vane Pump Parts (Cont.)

### Parts List for Cozzini® 400 Type Vane Pump

Position No.	Description	Cozzini Part Number
1	Housing pump	CVP3X002 <input checked="" type="checkbox"/>
2	Pump cover	CVP3X021 <input checked="" type="checkbox"/>
3	Cam	CVP3X006 <input checked="" type="checkbox"/>
4	Cover bushing	CVP3X012 <input checked="" type="checkbox"/>
5	Wear liner	CVP3X016 <input checked="" type="checkbox"/>
6	Thrust washer	CVP3X028 <input checked="" type="checkbox"/>
7	Vane set	CVP3X034 <input checked="" type="checkbox"/>
8	Rotor	CVP3X037 <input checked="" type="checkbox"/>
9	Bushing	07-001-0010 <input checked="" type="checkbox"/>
10	Thrust washer	98-SPX9P113B
11	Pump drive shaft	98-SPX9P111B <input checked="" type="checkbox"/>
12	Clamp	11-005-0111
13	Hinge pump and cover	CVP3X022
14	Adaptor hinge	CVP3X025
15	Hexagon bolt -3 8-16 NC - 5 NC	FNC10142
16	Hexagon nut nylon insert 3 8 - 16 NC	FNC04065
17	Hexagon bolt -3 8-16 UNC - 0.75 NC	03-012-1759
18	O-ring	12-001-0001 <input checked="" type="checkbox"/>
19	Socket bolt -3 8-16 NC - .75 NC	03-012-1759
20	Socket bolt -3 8-16 NC - 1.5 NC	03-012-1752



## Cozzini® Pump Parts - Type Vane Pump Parts (Cont.)

Full range of spare and wear parts for Cozzini® pumps – feel free to send us your parts number list plus the pump type/ model name in order for us to provide you with our quotation.



Cam heart shaped,  
part number CVP3X006 



Trust washer,  
part number 98SRX9P113B 



Bushing,  
part number 07-001-0010 



Vane set,  
part number CVP3X034 



Pump rotor,  
part number CVP3X037 



Pump drive shaft,  
part number 98-SPX9P111B 



Trust washer,  
part number CVP3X028 



Wear liner,  
part number CVP3X016 

## Cozzini® Pump Parts - Type Vane Pump Parts (Cont.)



Example of Cozzini® type pump



For complete new scansteel foodtech pumps:  
please ask scansteel foodtech for a quote for our scansteel foodtech pump

## Wolfking® / CFS® / GEA® Type Recoscreen - Mechanical Deboning Machine

### Parts Available for Mechanical Deboning Machine Types:

**RecoScreen(Deboner):** Type RS 100 and Type RS150

<b>FilterTypes:</b>	<u>Slit Filter</u>	<u>Hole Filter</u>
	0.4 /0.25mm	3.00mm
	1.5mm	3.25mm
	1.1mm	4.00mm
	0.8mm	5.25mm

**OtherParts:** Screw Cone



Slit filter for RecoScreen

### Pumps:

Type DC 200 (see pump section for details) Type DC 250 (see pump section for details)

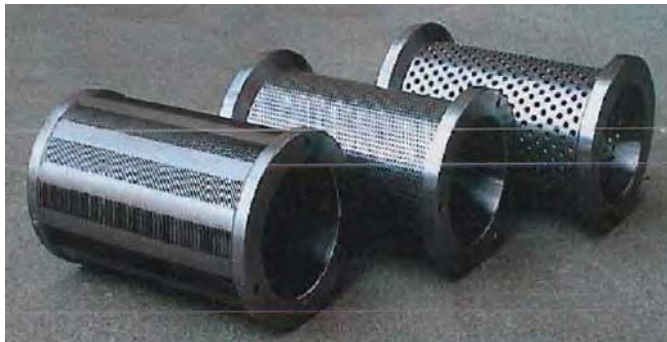

Slit and hole filter for RecoScreen



Worm for RecoScreen



### Wolfking® / CFS® / GEA® Type Recoscreen - Mechanical Deboning Machine (Cont.)

Machine Type	Description	Part Number
CFS® RecoScreen 100	Front bearing housing	1402-15

Machine Type	Description	Part Number
CFS® RecoScreen 100	Slit filter 0.4	1402-235
CFS® RecoScreen 100	Slit filter 0.25-0.4	1402-191
CFS® RecoScreen 100	Slit filter 0.5	1402-197
CFS® RecoScreen 100	Slit filter 0.4-0.5	1402-190
CFS® RecoScreen 100	Slit filter 0.5-0.65	1402-313
CFS® RecoScreen 100	Slit filter 0.25-0.5	1402-248
CFS® RecoScreen 100	Hole filter Ø1.2	1402-247
CFS® RecoScreen 100	Hole filter Ø2-3	1402-246
CFS® RecoScreen 100	Hole filter Ø2-0	1402-59
CFS® RecoScreen 100	Hole filter Ø3.0	1402-60
CFS® RecoScreen 100	Hole filter Ø4.0	1402-61
CFS® RecoScreen 100	Worm/Auger single flight	1402-276
CFS® RecoScreen 100	Worm/Auger three flight	1402-197

Machine Type	Description	Part Number
CFS® RecoScreen 150	Slit filter 0.25-0.4	1402-193
CFS® RecoScreen 150	Slit filter 0.25-0.5	1402-192
CFS® RecoScreen 150	Slit filter 0.7-0.5	1402-201
CFS® RecoScreen 150	Slit filter 0.5	1402-198
CFS® RecoScreen 150	Slit filter 0.6	1402-243
CFS® RecoScreen 150	Slit filter 0.8	1402-187
CFS® RecoScreen 150	Slit filter 0.9	1402-250
CFS® RecoScreen 150	Slit filter 1.0-3.0	1402-297
CFS® RecoScreen 150	Hole filter Ø2-0	1402-209
CFS® RecoScreen 150	Worm/Auger single flight	1402-300
CFS® RecoScreen 150	Worm/Auger single flight	1402-255
CFS® RecoScreen 150	Worm/Auger three flight	1402-270
CFS® RecoScreen 150	Worm/Auger three flight	1402-193
CFS® RecoScreen 150	Set with filter and worm/auger	405169

## Cozzini® Grinder Parts - Type CPG 400 Grinder Parts

### Exploded View of Cozzini® Grinder CPG 400 (Part 1 of 2)

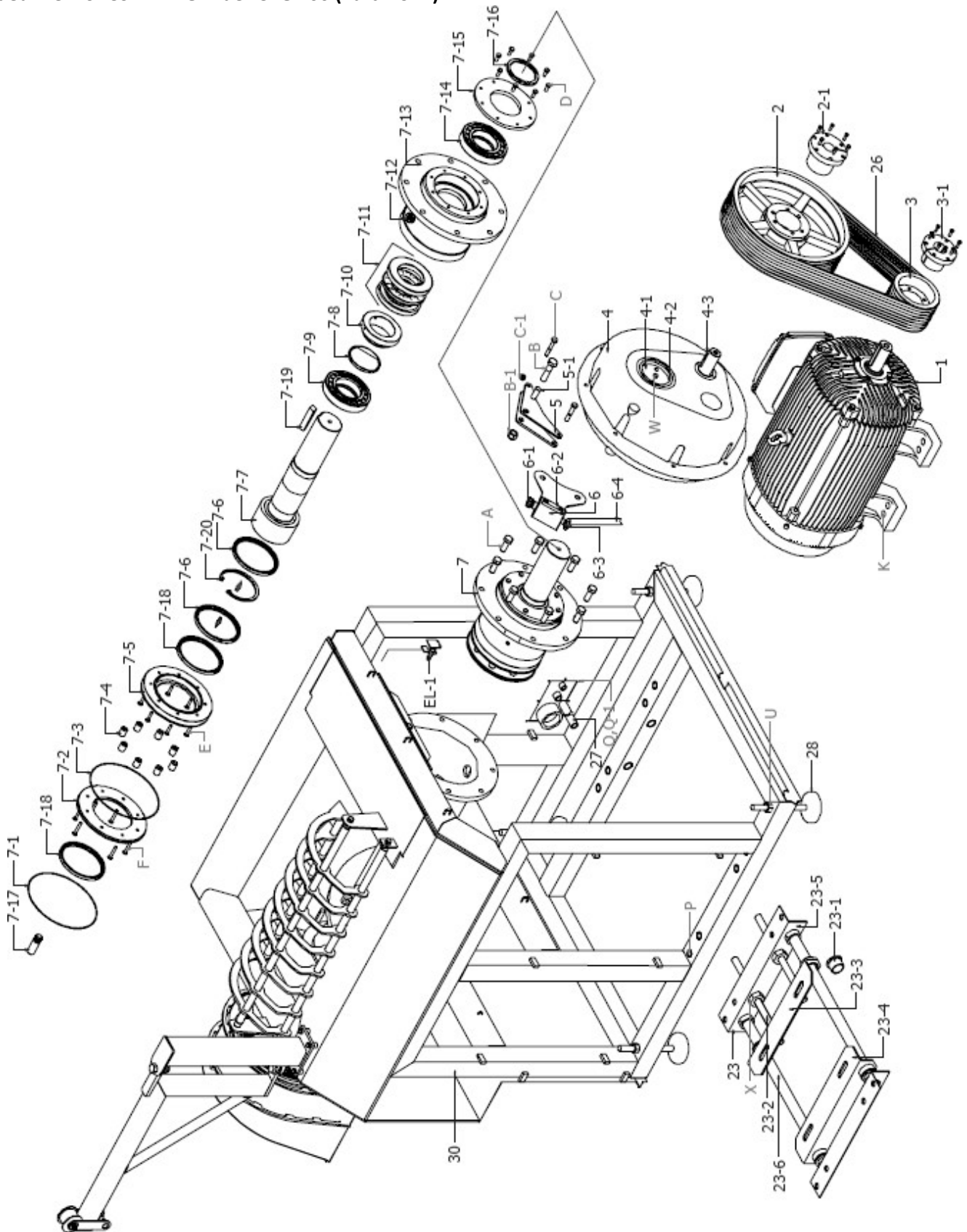

[www.koncepttech.com](http://www.koncepttech.com)

Koncept Tech ApS, Industrivej 6, DK-4200 Slagelse, Denmark, Phone: +45 70271410 E-mail: [parts@koncepttech.com](mailto:parts@koncepttech.com)

All items, parts, and accessories listed on the website of Koncept Tech ApS, are manufactured by Koncept Tech ApS, or manufactured by Koncept Tech ApS, specifications. The names of the original equipment manufacturers referred to on this site, such as but not limited to: Camiltech®, Handlmann®, K&G®, Krämer + Grebe®, CFS®, GEAB®, Karl Schnell®, KS®, Laska®, Palma®, Pelamo®, Seydelmann®, Simo®, Harslev®, Weller®, Mincmaster®, ANCO®, Cozzini®, The Middleby Corporation®, Wollking®, Comvair®, Auto®, Beehive®, Yieldmaster®, Meatmaker®, Poss®, Townsend®, Lima®, etc. are all registered trademarks of their respective companies. All original equipment manufacturer's names are listed as Camiltech® type, Handlmann® type, K&G® type, Krämer + Grebe® type, CFS® type, Karl Schnell® type, KS® type, Laska® type, Palma® type, Pelamo® type, Seydelmann® type, Simo® type, Harslev® type, Weller® type, Mincmaster® type, ANCO® type, Cozzini® type, Wollking® type, Comvair® type, Auto® type, Beehive® type, Yieldmaster® type, Meatmaker® type, Poss® type, Townsend® type, Lima® type to indicate that these items are manufactured by Koncept Tech ApS, and not the original equipment manufacturers. Unless specifically stated otherwise, Koncept Tech ApS, has no association or affiliation with any entities/companies listed.

## Cozzini® Grinder Parts - Type CPG 400 Grinder Parts (Cont.)

### Part List for Exploded View of Cozzini® Grinder CPG 400 (Part 1 of 2)

Pos. No.	Description	Part Number	Qty.
1	Motor 150 HP 380/3/50 280S/M TEFC	02-001-0847	1
2	Pulley, 8 groove SPB 355/8	03-003-0170	
2-1	Bushing, 55mm	03-002-0446	
3	Pulley, 8 groove Ø13,2	03-003-0171	
3-1	Bushing	03-002-0447	
4	Gear reducer	CPG400-45	
4-1	Gear reducer cap	PG400448	
4-2	Gear reducer cap retainer clip	PG400449	
4-3	Gear reducer key		
5	PG400 torque arm bracket 460V	PG400446	
5-1	Spacer reducer, torque arm mount.	PG400447	
6	CPG400 filler breather assembly	PG400409	
6-1	Filler breather 3/4" NPT	04-013-0023	
6-2	Level gauge	04-013-0022	1
6-3	Male branch tee 3/8 NPTF-brass	11-007-004	
6-4	Oil hose		
7	Drive shaft-bearing housing, complete	P400400	1
7-2	Back seal plate – bearing housing	PG400417	
7-4	Stand off - bearing housing plate	PG400416	
7-5	Cover - bearing housing	PG400415	1
7-6	Lip seal	12-002-1654	1
7-7	Drive shaft for CPG400	PG400418	1
7-8	Oil seal	12-002-0053	1
7-9	Roller bearing	03-001-1653	1
7-10	Intermediate ring	PG400419	1
7-11	Thrust ball bearing	03-001-1652	1
7-12	Filler breather, 3/8" NPT	04-013-0024	
7-13	Drive shaft		1
7-14	Roller bearing	03-001-1653	1
7-15	Bearing housing seal plate	PG400414	
7-16	Oil seal	12-002-0053	1
7-17	Drive shaft centering pin	PG400424	1
7-18	Lip seal (wiper)	12-002-1654	1

## Cozzini® Grinder Parts - Type CPG 400 Grinder Parts (Cont.)

### Exploded View of Cozzini® Grinder CPG 400 (Part 2 of 2)

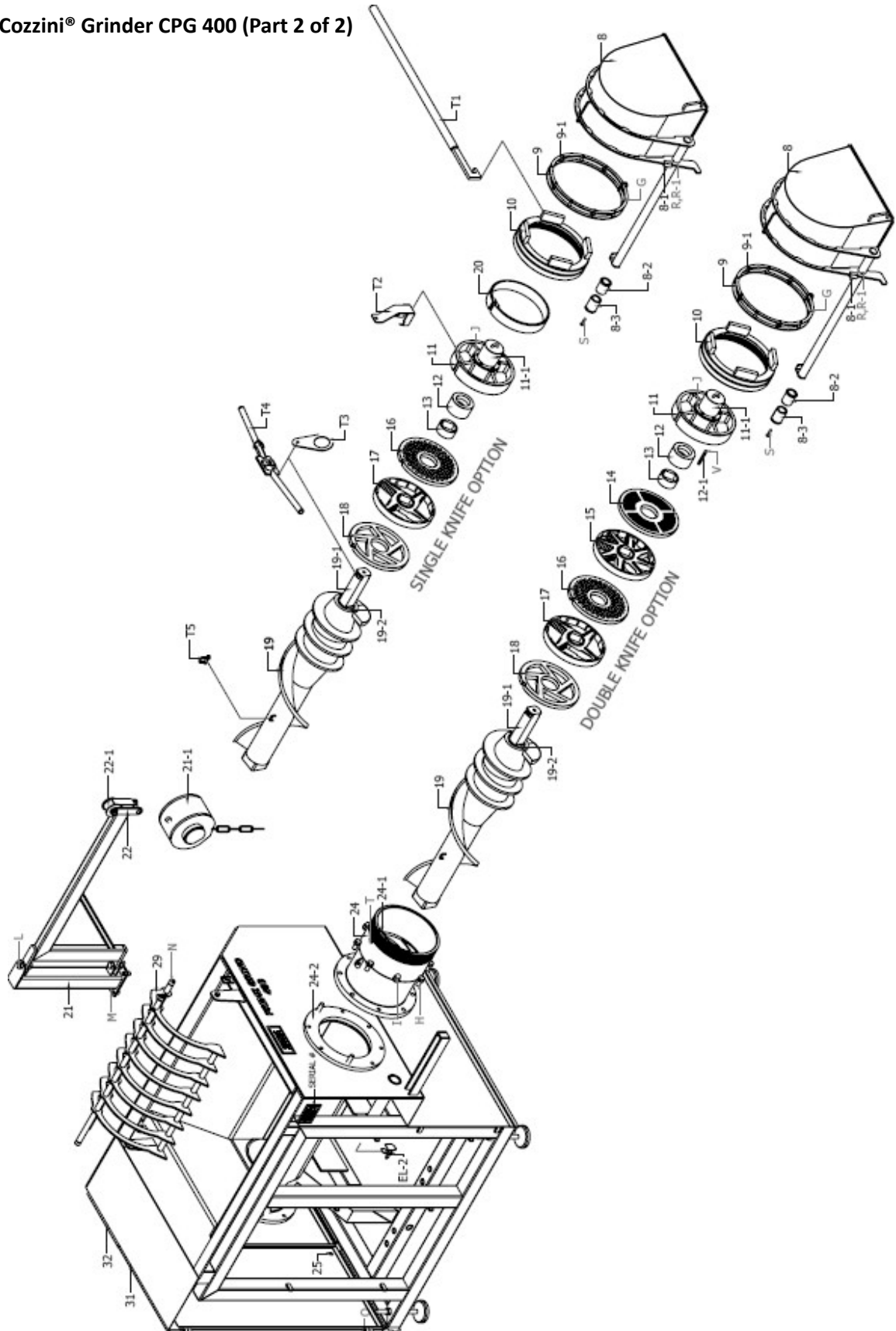

[www.koncepttech.com](http://www.koncepttech.com)

Koncept Tech ApS, Industrivej 6, DK-4200 Slagelse, Denmark, Phone: +45 70271410 E-mail: [parts@koncepttech.com](mailto:parts@koncepttech.com)

All items, parts, and accessories listed on the website of Koncept Tech ApS, are manufactured by Koncept Tech ApS, or manufactured by Koncept Tech ApS, specifications. The names of the original equipment manufacturers referred to on this site, such as but not limited to: Camiltech®, Handlmann®, K&G®, Krämer + Grebe®, CFS®, GEA®, Karl Schnell®, KS®, Laska®, Palma®, Pelmo®, Seydelmann®, Simo®, Harslev®, Weller®, Mincomaster®, ANCO®, Cozzini®, The Middleby Corporation®, Wolfking®, Comvair®, Auto®, Beehive®, Yieldmaster®, Meatmaker®, Poss®, Townsend®, Lima® etc. are all registered trademarks of their respective companies. All original equipment manufacturer's names are listed as Camiltech® type, Handlmann® type, K&G® type, CFS® type, Karl Schnell® type, KS® type, Laska® type, Palma® type, Pelmo® type, Seydelmann® type, Simo® type, Harslev® type, Weller® type, Mincomaster® type, ANCO® type, Cozzini® type, Wolfking® type, Comvair® type, Auto® type, Beehive® type, Yieldmaster® type, Meatmaker® type, Poss® type, Townsend® type, Lima® type to indicate that these items are manufactured by Koncept Tech ApS, and not the original equipment manufacturers. Unless specifically stated otherwise, Koncept Tech ApS, has no association or affiliation with any entities/companies listed.



Follow us on LinkedIn

Follow us on Facebook

## Cozzini® Grinder Parts - Type CPG 400 Grinder Parts (Cont.)

### Exploded View of Cozzini® Grinder CPG 400 (Part 2 of 2)

Pos. No.	Description	Part Number	Qty.
8	Discharge guard - CPG400	PG400800	
8-1	UHMW guard slide	PG400866	
8-2	Guard front-back bushing	PG400830-1	
9	Mounting ring for locking ring	CPG400-43-MR	
10	Ring	PG400143	
11	Bearing housing support ring – idle	PG400138	
11-1	Cover for supporting ring	PG400144	
12	Plastic bushing	CPG400-37P	
12-1	Key for bushing CPG400-37P	CPG400-37K	
13	Bushing, knife pin-needle bearing	PG400136	
14	Hole plate		
15	Ring knife		
16	Hole plate		
17	Ring knife		
21	CPG400 Lift crane	CPG400-CRN	
21-1	Hoist, 1 ton Cap	03-015-0028	
22	CPG400 Roller for crane assy	CPG400-CRN-Roller	
22-1	Crane roller for CPG400 Crane	CPG400-CRN-Roller	
24	Head section	PG400121	
24-1	Key, head section	PG400126	
25	Southco vise action clamp	03-011-0004	
25-1	Latch key vs panel	03-011-0005	
26	Belt gripnoch 5Vx1120	03-008-0071	
29	Hopper guide weldment	CPG400-HGW	



## Cozzini® Grinder Parts - Gear Box Parts

Machine Type	Description	Part Number
Cozzini® CPG 400 Grinder	Bonfiglioli shaft gear box, type TA 125-125/D	<a href="#">SC-gr320-MG400xPos.36</a>



Bonfiglioli shaft gear box type TA 125-125/D, part number [scgr320-MG400xPos.36](#)

## Cozzini® Grinder Parts - Type EM 701 and AR 901 Grinder Parts

Machine Type	Description	Part Number
Cozzini®EM 701	Cutting head seal	EM-1363



Cutting head seal for Cozzini®EM 701, part number EM-1363

Machine Type	Description	Part Number
Cozzini®AR 901	Gristle ring AR 901	EM-1014
Cozzini®AR 901	Lock washer 901/VM7	EM-1042-14



Lock washer 901/VM7,  
partnumberEM-1042-14



Gristle ring AR901  
part number EM-1024

### Cozzini® Grinder Parts - Miscellaneous Grinder Parts

Machine Type	Description	Part Number
Miscellaneous Cozzini® grinder parts	Gasket for vacuum lid	12-004-0010
Miscellaneous Cozzini® grinder parts	3/8" – 16 x 3/4" Long SS	FNC12388
Miscellaneous Cozzini® grinder parts	Valve 3" O-ring	EMP-D12-8
Miscellaneous Cozzini® grinder parts	Gasket	EMP-1170-54
Miscellaneous Cozzini® grinder parts	Vacuum hose 1-1/2"	06-005-0003
Miscellaneous Cozzini® grinder parts	O-ring	3X12-001-00001
Miscellaneous Cozzini® grinder parts	Lip seal 23x4557	12-002-0001
Miscellaneous Cozzini® grinder parts	Lip seal 23x2537	12-002-014
Miscellaneous Cozzini® grinder parts	Lip seal 23x2657	12-002-005



3/8" – 16 x 3/4" LongSS,  
part number FNC12388



Valve 3" O-ring,  
part number EMP-D12-8



Lip seal 23x4557,  
part number 12-002-0001



Gasket for vacuum lid,  
part number 12-004-0010



Lip seal 23X2537,  
part number 12-002-0014



Lip seal 23X2657,  
part number 12-002-005



Gasket,  
part number EMP-1170-54



Vacuum hose 1-1/2",  
part number 06-005-0003

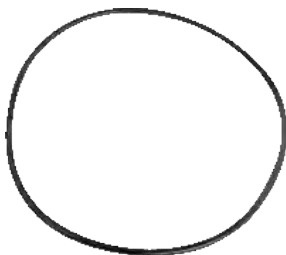

O-ring,  
part number 3X12-001-00001

## Wolfking® CFS® ContiGrind

Machine Type	Description	Part Number
Wolfking® TwinScrewPump / TSP CFS® TwinScrewPump / TSP / Contigrind 95	Lining for Contigrind	5000310774 310774
Wolfking® TwinScrewPump / TSP CFS® TwinScrewPump / TSP / Contigrind 95	Worm for Contigrind (Primary) stain- less steel **	5000315505 315505
Wolfking® TwinScrewPump / TSP CFS® TwinScrewPump / TSP / Contigrind 95	Worm for Contigrind (Secondary) stainless steel **	5000315506 315506
Wolfking® TwinScrewPump / TSP CFS® TwinScrewPump / TSP / Contigrind 95	Worm for Contigrind (Primary) POM	5000313120 313120
Wolfking® TwinScrewPump / TSP CFS® TwinScrewPump / TSP / Contigrind 95	Worm for Contigrind (Secondary) POM	5000313121 313121

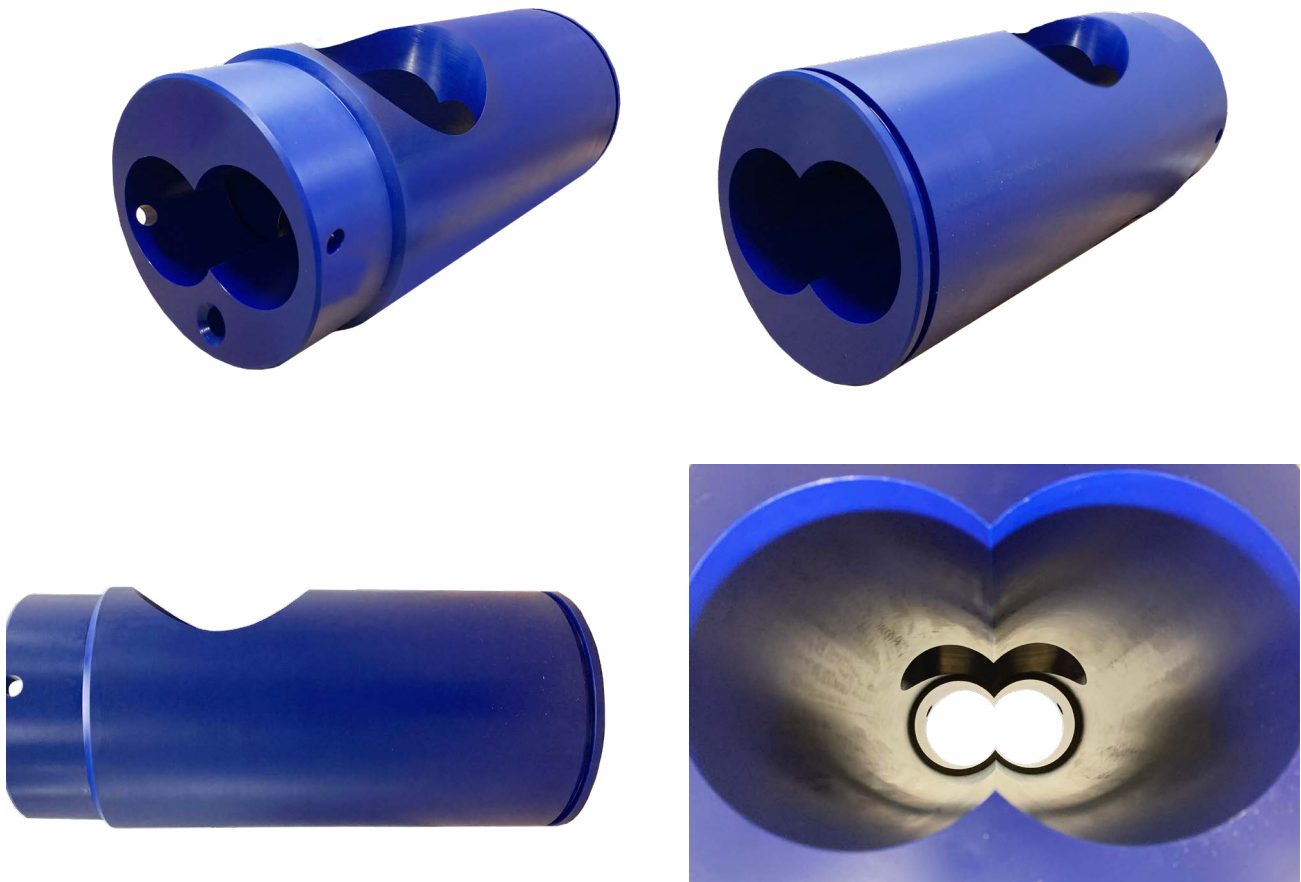

## Refurbishment and Exchange Parts

### **Refurbishments and Exchange Parts**

For all worms/augers, linings, knife housings, and gear boxes we are able to supply you with a repair service. You send us the part that needs refurbishment and we return the refurbished part to you. Furthermore, we also offer you the possibility to get an extra 15% discount when buying new parts! This discount will be obtained when you return your old worm/auger, lining, knife housing, or gear box.



Ø400 knife housing refurbished



David Brown gear box for C.400/B.400-UNI/Heavy Duty



Gear box for C.400 refurbished



Lining for Simo® grinder before refurbishment

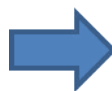

Lining for Simo® grinder refurbished

## Refurbishment and Exchange Parts (Cont.)



David Brown gear box before refurbishment

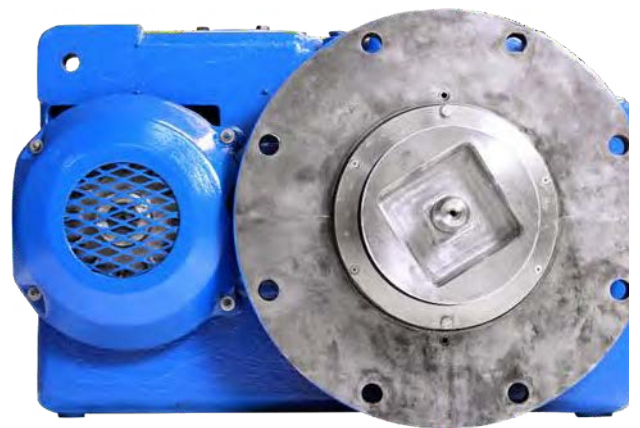

David Brown gear box after refurbishment



David Brown gear box before refurbishment



David Brown gear box after refurbishment

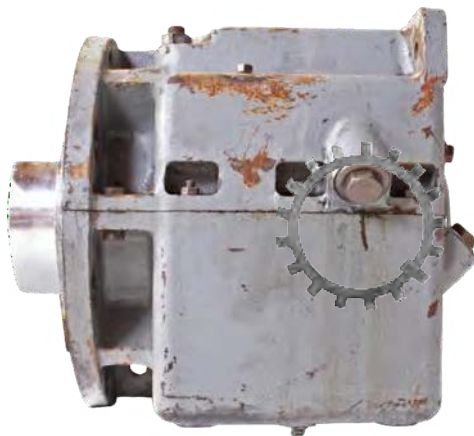

David Brown gear box before refurbishment

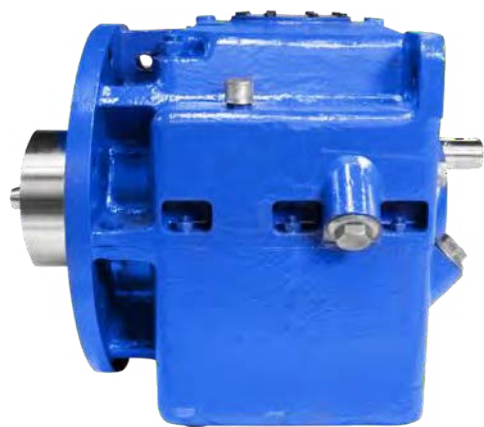

David Brown gear box after refurbishment

## Refurbishment and Exchange Parts (Cont.)

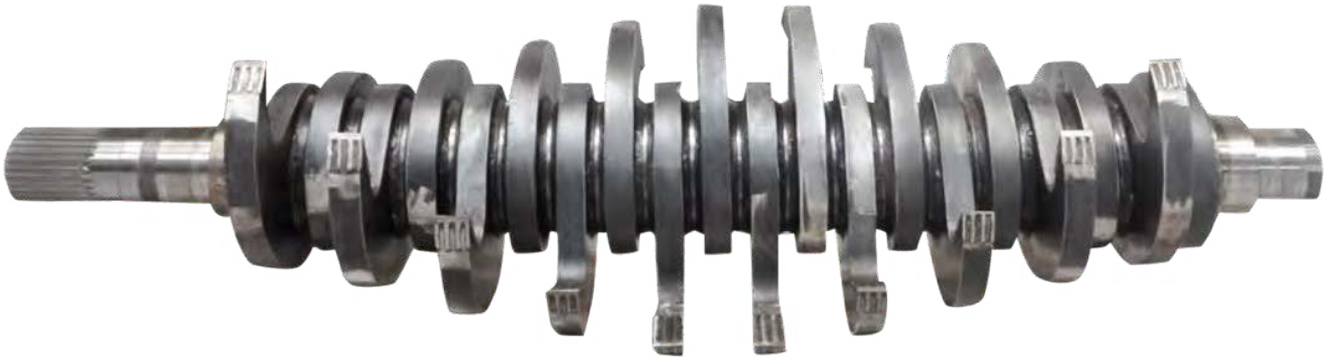

Refurbished crusher claw



[www.koncepttech.com](http://www.koncepttech.com)

Koncept Tech ApS, Industrivej 6, DK-4200 Slagelse, Denmark, Phone: +45 70271410 E-mail: [parts@koncepttech.com](mailto:parts@koncepttech.com)

All items, parts, and accessories listed on the website of Koncept Tech ApS, are manufactured by Koncept Tech ApS, or manufactured to Koncept Tech ApS, specifications. The names of the original equipment manufacturers referred to on this site, such as but not limited to: Camiltech®, Handlmann®, K&G®, Krämer + Grebe®, CFS®, GEAB®, Karl Schnell®, KS®, Laska®, Palma®, Pelsmo®, Seydelmann®, Simo®, Hørslev®, Weiler®, Mincomaster®, ANCO®, Cuzzini®, The Middleby Corporation®, Wölfling®, Comvair®, Auto®, Beehive®, Yieldmaster®, Meatmaker®, Poss®, Townsend®, Lima® etc. are all registered trademarks of their respective companies. All original equipment manufacturer's names are listed as Camiltech® type, Handlmann® type, K&G® type, Krämer + Grebe® type, CFS® type, Karl Schnell® type, KS® type, Laska® type, Palma® type, Pelsmo® type, Seydelmann® type, Simo® type, Hørslev® type, Weiler® type, Mincomaster® type, ANCO® type, Cuzzini® type, Wölfling® type, Comvair® type, Auto® type, Beehive® type, Yieldmaster® type, Meatmaker® type, Poss® type, Townsend® type, Lima® type to indicate that these items are manufactured by Koncept Tech ApS, and not the original equipment manufacturers. Unless specifically stated otherwise, Koncept Tech ApS, has no association or affiliation with any entities/companies listed.



Follow us on LinkedIn

Follow us on Facebook

## Refurbishment and Exchange Parts (Cont.)

### **Refurbishments** of Filter and Worm for Lima® and Recoscreen®- Mechanical Deboning Machines

We offer a repair service for your filter and worm for Lima® and Recoscreen®- Mechanical Deboning Machines. Your filter and worm will be repaired as a set as it is important that worm and filter match a 100%, so you will obtain the best results with your machine.

We are able to pick up the parts at your site and to return the repaired items to you – we can arrange the repair as it fits your needs.







Follow us on LinkedIn



Follow us on Facebook

New Machines - [www.scansteelfoodtech.com](http://www.scansteelfoodtech.com)



## THE SCANSTEEL FOODTECH GROUP – [www.scansteelfoodtech.com](http://www.scansteelfoodtech.com)

- Supplier of our own manufactured grinders, mixers, vacuum mixers, mixer/grinders, pumps, emulsifiers, silos, conveyors, as well as complete processing lines.
- scansteel foodtech Group is among the World's most innovative manufacturers of food preparation machinery, equipment, and complete processing lines and solutions for the global food processing industry. The main focus is on the global meat, poultry, and cheese processing industries as well as on the global pet food, rendering, and fur industry.

scansteel foodtech  
MADE IN DENMARK

[www.koncepttech.com](http://www.koncepttech.com)

Koncept Tech ApS, Industrivej 6, DK-4200 Slagelse, Denmark, Phone: +45 70271410 E-mail: [parts@koncepttech.com](mailto:parts@koncepttech.com)

All items, parts, and accessories listed on the website of Koncept Tech ApS, are manufactured by Koncept Tech ApS, or manufactured to Koncept Tech ApS, specifications. The names of the original equipment manufacturers referred to on this site, such as but not limited to: Camiltech®, Handtmann®, K&G®, Krämer + Grebe®, CFS®, GEAB®, Karl Schnell®, KS®, Laska®, Palmia®, Pelsmo®, Seydelmann®, Simo®, Hørslev®, Weiler®, Mincmaster®, ANCO®, Cozzini®, The Middleby Corporation®, Wolkling®, Comvair®, Audio®, Beehive®, Yieldmaster®, Meatmaker®, Poss®, Townsend®, Lima®, etc., are all registered trademarks of their respective companies. All original equipment manufacturer's names are listed as Camiltech® type, Handtmann® type, K&G® type, Krämer + Grebe® type, CFS® type, Karl Schnell® type, KS® type, Laska® type, Palmia® type, Pelsmo® type, Seydelmann® type, Simo® type, Hørslev® type, Weiler® type, Mincmaster® type, ANCO® type, Cozzini® type, Wolkling® type, Comvair® type, Audio® type, Beehive® type, Yieldmaster® type, Meatmaker® type, Poss® type, Townsend® type, Lima® type to indicate that these items are manufactured by Koncept Tech ApS, and not the original equipment manufacturers. Unless specifically stated otherwise, Koncept Tech ApS, has no association or affiliation with any entities/companies listed.

### Meet Our Global Team

Australia



**Mr. Jamie Culpitt**  
**Focus Engineering P/LT/A Focus Trading**

Company phone: +61 (0)407 871 873  
E-Mail: spareparts@focustrading.com.au

Brazil



**Mr. Carlos Jorge**  
Mobile: +55 11 95551-7724  
E-mail: carlos.jorge@fimach.com.br

**Mr. Antonio Carlos Filleti**  
Mobile: +55 11 98331-0887  
E-mail: antonio.filleti@fimach.com.br

Denmark



**Mrs. Helle Friis Olsen**  
Sales and global agentsupport  
Telephone: +45 21 28 2785  
Fax: +45 70 27 1411  
E-Mail: helle@koncepttech.com

**Mrs. Maria Ravnskjær**  
Sales and global agent support  
Telephone: +45 29 17 1424  
Fax: +45 70 27 1411  
E-Mail: maria@koncepttech.com

France



**Mr. Alain Thiriot**  
**BFR Lassoudry**  
Telephone: +33 (0)1 69 11 9016  
E-mail: a.thiriot@bfrsystems.com

Greece



**Mrs. Helle Friis Olsen**  
Sales and global agent support  
Telephone: +45 21 28 2785  
Fax: +45 70 27 1411  
E-Mail: helle@koncepttech.com

**Mrs. Maria Ravnskjær**  
Sales and global agent support  
Telephone: +45 29 17 1424  
Fax: +45 70 27 1411  
E-Mail: maria@koncepttech.com

### Meet Our Global Team

Israel



**Mr. Raz Pessach**  
 Business and development  
 Mobile: +972 (0)52 6440318  
 Company phone: +972 9865 1152  
 E-Mail: raz@pessach.net

**Mrs. Orit Sadeh**  
 Marketing & customer relations manager  
 Company phone: +972 9865 1152  
 E-Mail: marketing@pessach.net

Italy



**Mr. Andrea Lazzari**  
 Company phone: +39 (0)45 8350877  
 E-Mail: andrea@lazzariegquipment.com

The Netherlands / Belgium



**Mr. Harry Jorissen**  
 Mobile: +31 (0) 6 11867762  
 E-mail: harry@vertec.nl

New Zealand



**Mrs. Sandie Hussey**  
**Food Machinery Imports and Servicing**  
 Telephone: +64 (07) 8553633  
 Mobile: +64 (021) 895330  
 E-mail: mike@foodmis.co.nz

New Zealand



**Mrs. Sandie Hussey**  
**Food Machinery Imports and Servicing**  
 Telephone: +64 (07) 8553633  
 Mobile: +64 (021) 895330  
 E-mail: mike@foodmis.co.nz



Follow us on LinkedIn



Follow us on Facebook

## Meet Our Global Team

Peru



# Koncept Tech

Parts Portal

**Mrs. Helle Friis Olsen**

Sales and global agentsupport  
Telephone: +45 21 28 2785  
Fax: +45 70 27 1411  
E-Mail: helle@koncepttech.com

**Mrs. Maria Ravnskjær**

Sales and global agent support  
Telephone: +45 29 17 1424  
Fax: +45 70 27 1411  
E-Mail: maria@koncepttech.com

Poland



**premac** *technologie pakowania*

**Mrs. Marta Staniszevska**

Telephone: +48 531 464264  
E-Mail: serwis@premac.pl

**Mr. Wojciech Nawrocki**

Telephone: +48 531 463475  
E-Mail: w.nawrocki@premac.pl

Russia



ТЕХНОЛОГИИ  
ПИЩЕВОЙ  
ПРОМЫШЛЕННОСТИ

**Mr. Alexander Bobrow**

E-mail: aab@foodpromtech.ru

**Ms. Irina Vanavskaya**

Email: via@foodpromtech.ru

**Ms. Galina Mozalevsckaya**

E-mail: mga@foodpromtech.ru

South Africa



**SUMMIT**  
PROCESS SOLUTIONS

**Mr. Rodney Macer-Wright**

Mobile: +27 (0) 82 3219447  
Telephone: +27 (0) 11 4660408  
E-mail: rodney@summitpros.co.za

Spain



# Koncept Tech

Parts Portal

**Mrs. Helle Friis Olsen**

Sales and global agentsupport  
Telephone: +45 21 28 2785  
Fax: +45 70 27 1411  
E-Mail: helle@koncepttech.com

**Mrs. Maria Ravnskjær**

Sales and global agent support  
Telephone: +45 29 17 1424  
Fax: +45 70 27 1411  
E-Mail: maria@koncepttech.com

## Meet Our Global Team

Turkey



**Mr. Bahadır KABASAKAL**  
Telephone: +90 532 737 19 29  
E-mail: bahadir@albateknik.com

Ukraine



**Mrs. Anastasia Yarmolenko**  
Head of Department After  
Sales and Service

Mobile: +38 0674726443  
Phone: +38 0443907338  
E-mail: s2@steiner.com.ua

UK / Ireland



**Mr. Chris Keenan**  
Sales Executive  
Mobile: +44 (0)845 2932910  
E-Mail: ck@selo.eu

**Mr. Barry France**  
Sales Executive  
Mobile: +44 (0) 7766 965 886  
E-Mail: bf@selo.eu

**Ms. Joanne Roberts**  
Customer Support Administrator  
Mobile: +44 (0)845 293 5990  
E-Mail: jr@selo.eu

**Managing Director:**  
**Mr. Charles Parker**  
E-Mail: cparker@scanamcorp.com

**Sales:**  
**Mr. Aaron Chabino**  
E-Mail: achabino@scanamcorp.com

USA



**Spare Parts:**  
**Mr. Greg Cole**  
Phone: +1 816 2105528  
E-Mail: gcole@scanamcorp.com

**Koncept Tech ApS Member of scansteel foodtech Group**

## **Koncept Tech ApS member of scansteel foodtech group**



**10,450 m<sup>2</sup> factory in Denmark**

### **Headquarters of:**

- **Koncept Tech ApS**
- **scansteel foodtech A/S**

[www.koncepttech.com](http://www.koncepttech.com)

Koncept Tech ApS, Industrivej 6, DK-4200 Slagelse, Denmark, Phone: +45 70271410 E-mail: [parts@koncepttech.com](mailto:parts@koncepttech.com)

All items, parts, and accessories listed on the website of Koncept Tech ApS, are manufactured by Koncept Tech ApS, or manufactured to Koncept Tech ApS, specifications. The names of the original equipment manufacturers referred to on this site, such as but not limited to: Camiltech®, Handlmann®, K&G®, Krämer + Grebe®, CFS®, GEAB®, Karl Schnell®, KS®, Laska®, Palmia®, Pelsmo®, Seydelmann®, Simo®, Hørslev®, Weiler®, Mincmaster®, ANCO®, Cozzini®, The Middleby Corporation®, Wolfking®, Comvair®, Auto®, Beehive®, Yieldmaster®, Meatmaker®, Poss®, Townsend®, Lima®, etc., are all registered trademarks of their respective companies. All original equipment manufacturer's names are listed as Camiltech® type, Handlmann® type, K&G® type, Krämer + Grebe® type, CFS® type, Karl Schnell® type, KS® type, Laska® type, Palmia® type, Pelsmo® type, Seydelmann® type, Simo® type, Hørslev® type, Weiler® type, Mincmaster® type, ANCO® type, Cozzini® type, Wolfking® type, Comvair® type, Auto® type, Beehive® type, Yieldmaster® type, Meatmaker® type, Poss® type, Townsend® type, Lima® type to indicate that these items are manufactured by Koncept Tech ApS, and not the original equipment manufacturers. Unless specifically stated otherwise, Koncept Tech ApS, has no association or affiliation with any entities/companies listed.